

E70190

Height: 800  
Width: 400  
Depth: 100

Tube  $\phi$  : 31.8 + 22  
Pipe Centres / Face-Face Cons: 368  
Output @ 50° C  $\Delta$  T Watts: 197 W  
BTUs: 672 W

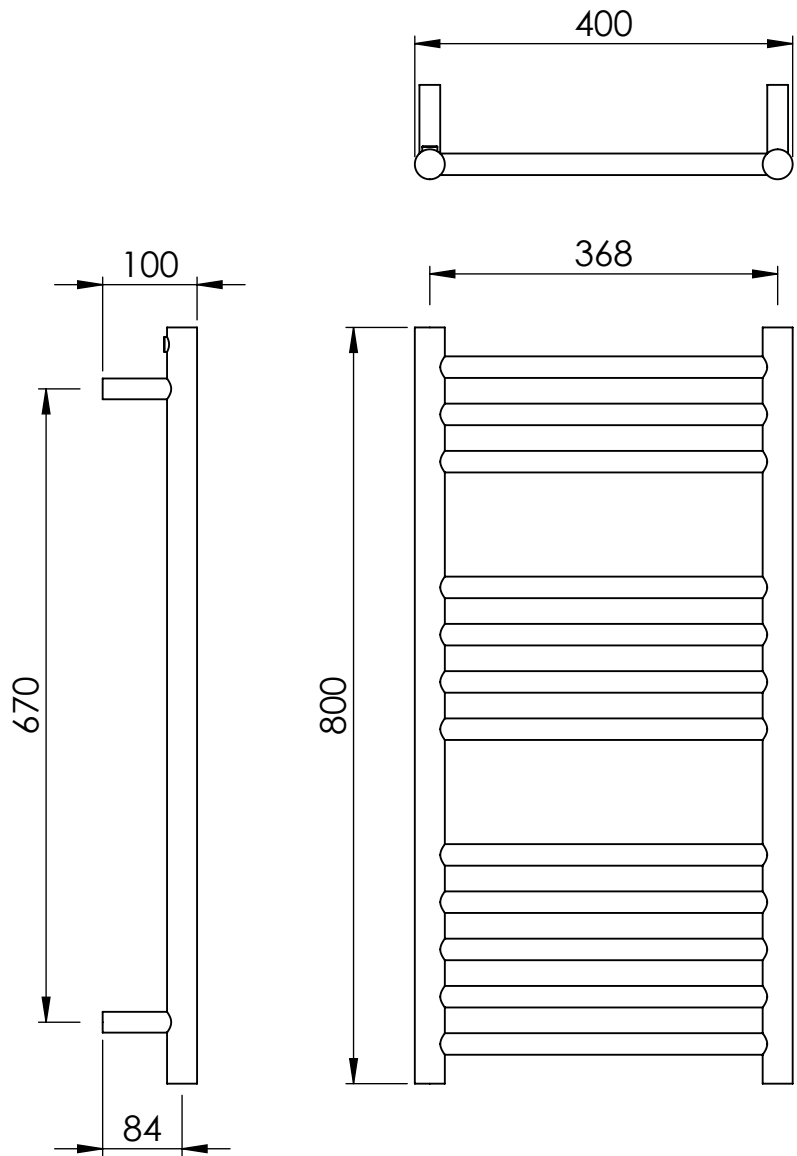
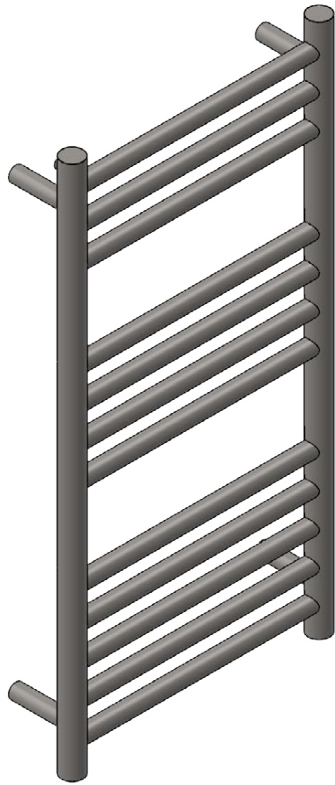

**esteem**<sup>®</sup>  
bathrooms

Narva Straight

All dimensions in millimetres

Manufactured from 1.4301/X5CrNi18-10 stainless steel

SCALE 1:8

E70191

Height: 800  
Width: 400  
Depth: 100

Tube  $\phi$  : 31.8 + 22  
Pipe Centres / Face-Face Cons: 368  
Elec. element if specified: 100 W

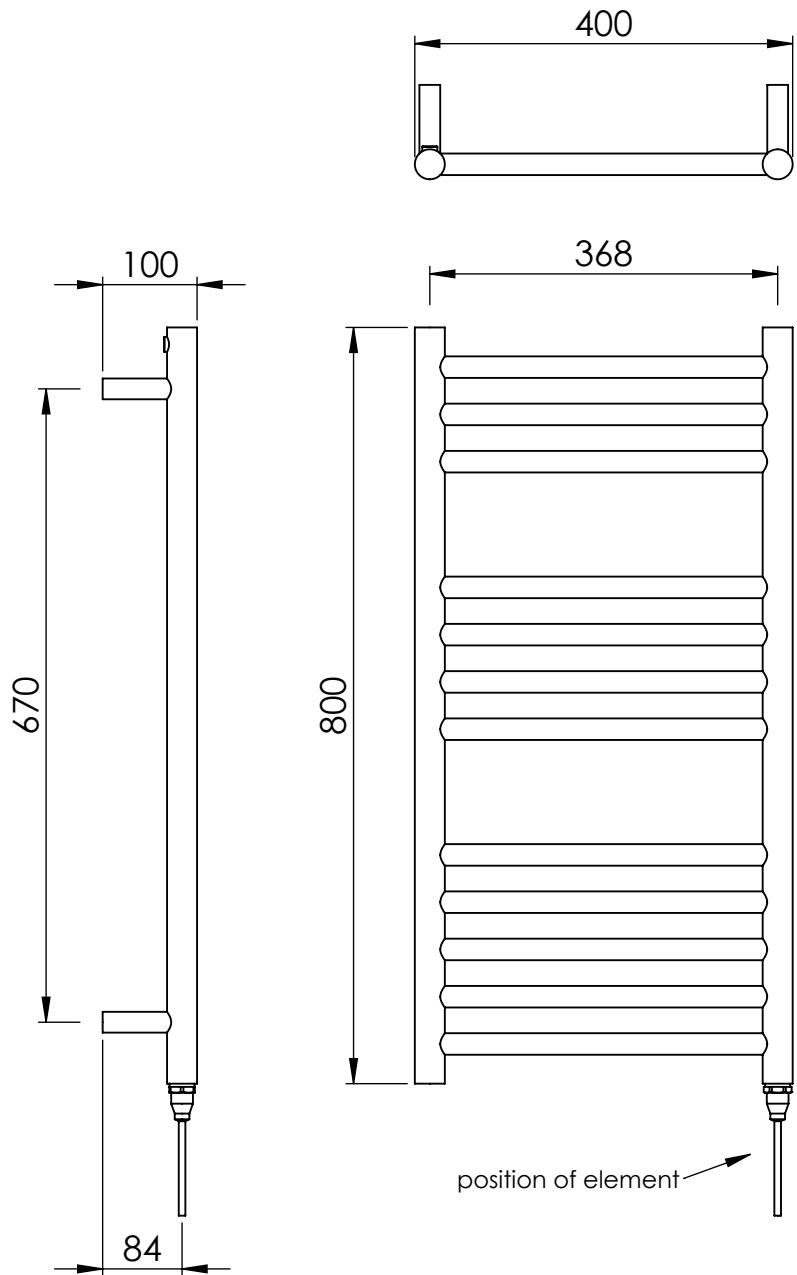
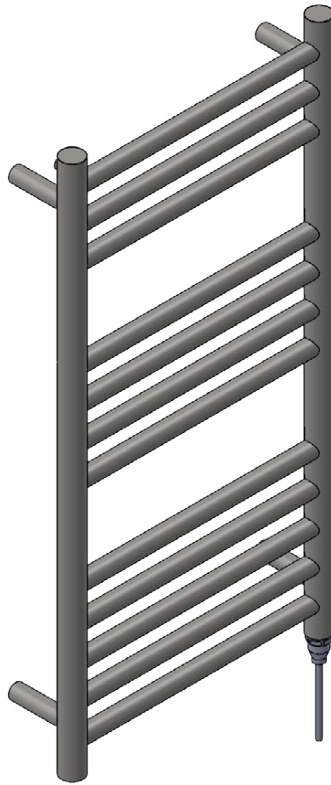

**esteem**<sup>®</sup>  
bathrooms

Narva Straight

All dimensions in millimetres

Manufactured from 1.4301/X5CrNi18-10 stainless steel

SCALE 1:8

E70192

Height: 800  
Width: 400  
Depth: 100

Tube  $\phi$  : 31.8 + 22  
Pipe Centres / Face-Face Cons: 368  
Elec. element if specified: 100 W  
Output @ 50° C  $\Delta$  T Watts: 197 W  
BTUs: 672 W

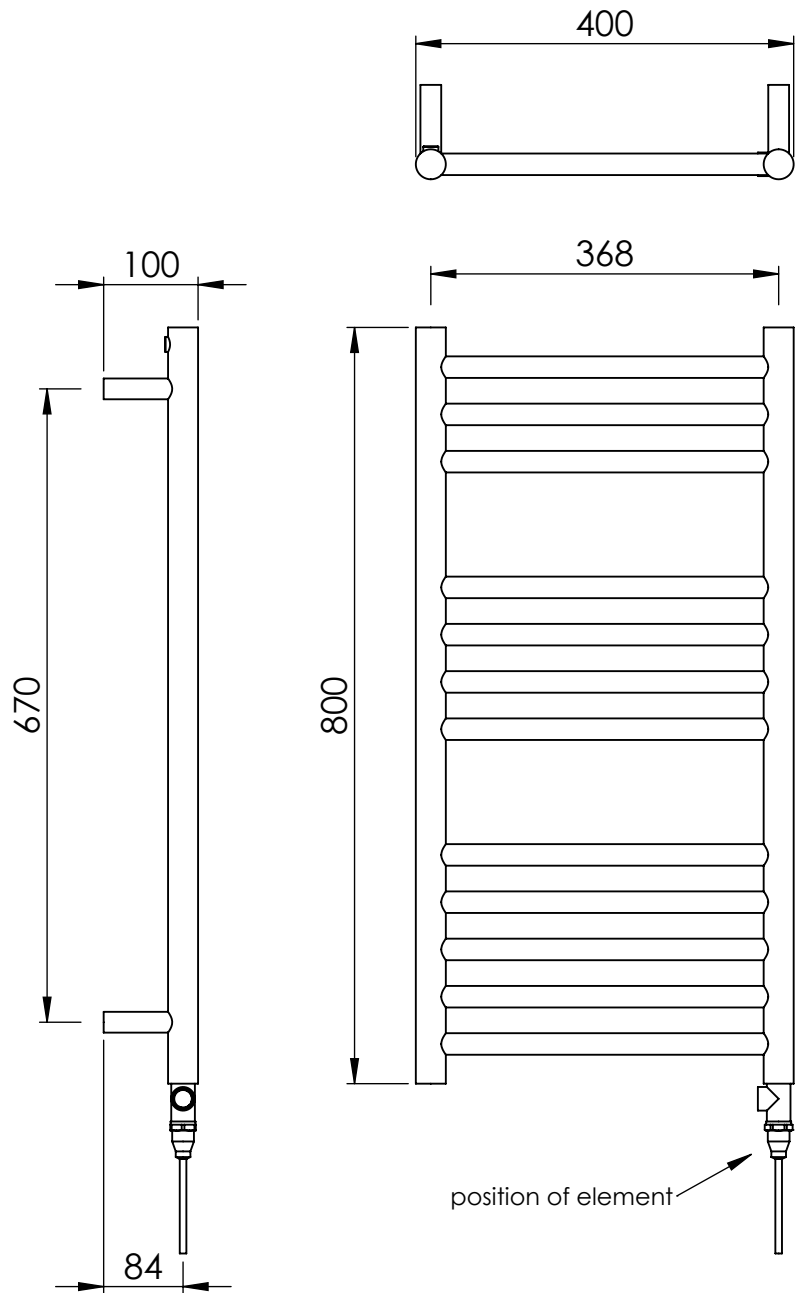
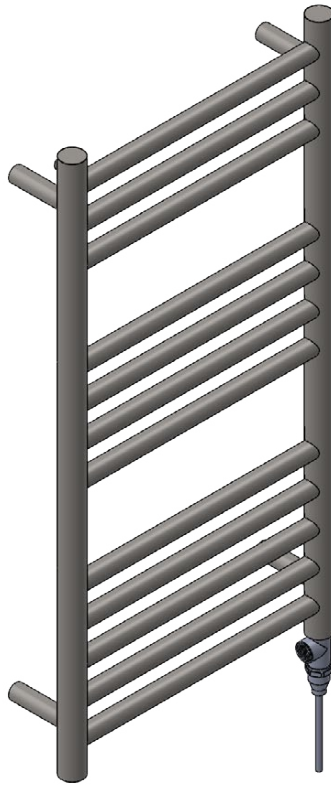

Narva Straight

All dimensions in millimetres

Manufactured from 1.4301/X5CrNi18-10 stainless steel

SCALE 1:8

E70193

Height: 800  
Width: 500  
Depth: 100

Tube  $\phi$  : 31.8 + 22  
Pipe Centres / Face-Face Cons: 468  
Output @ 50° C $\Delta$  T Watts: 243 W  
BTUs: 829 W

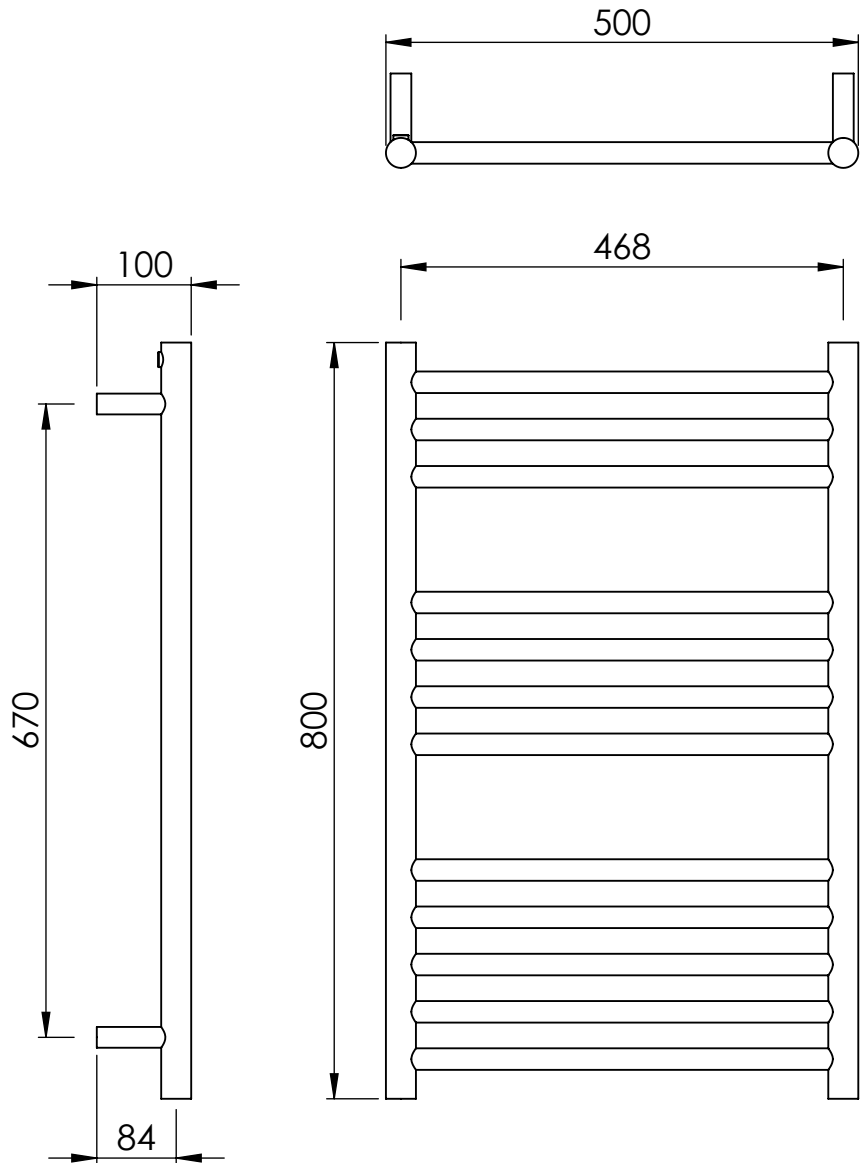
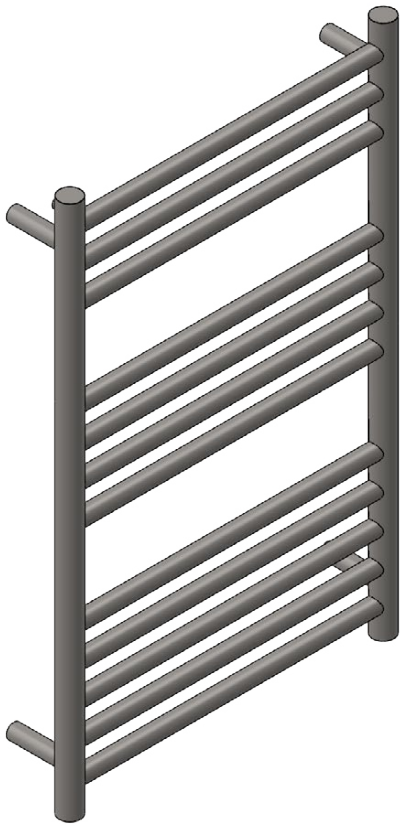

Narva Straight

All dimensions in millimetres

Manufactured from 1.4301/X5CrNi18-10 stainless steel

SCALE 1:8

E70194

Height: 800  
Width: 500  
Depth: 100

Tube  $\phi$  : 31.8 + 22  
Pipe Centres / Face-Face Cons: 468  
Elec. element if specified: 125 W

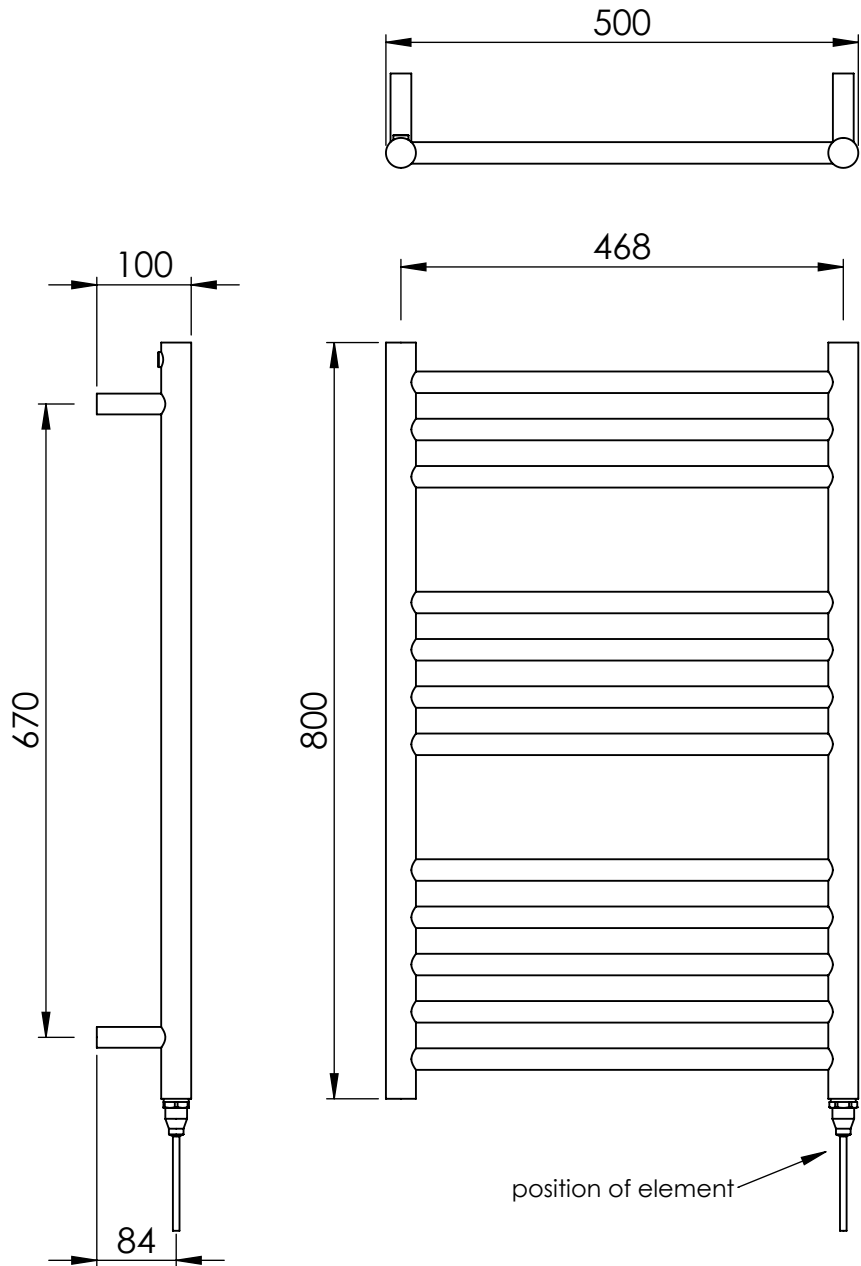
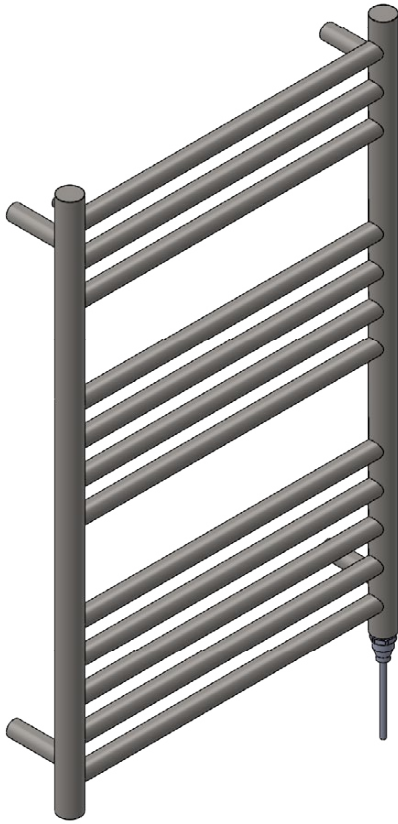

**esteem**<sup>®</sup>  
bathrooms

Narva Straight

All dimensions in millimetres

Manufactured from 1.4301/X5CrNi18-10 stainless steel

SCALE 1:8

E70195

Height: 800  
Width: 500  
Depth: 100

Tube  $\phi$  : 31.8 + 22  
Pipe Centres / Face-Face Cons: 468  
Elec. element if specified: 125 W  
Output @ 50° C  $\Delta$  T Watts: 243 W  
BTUs: 829 W

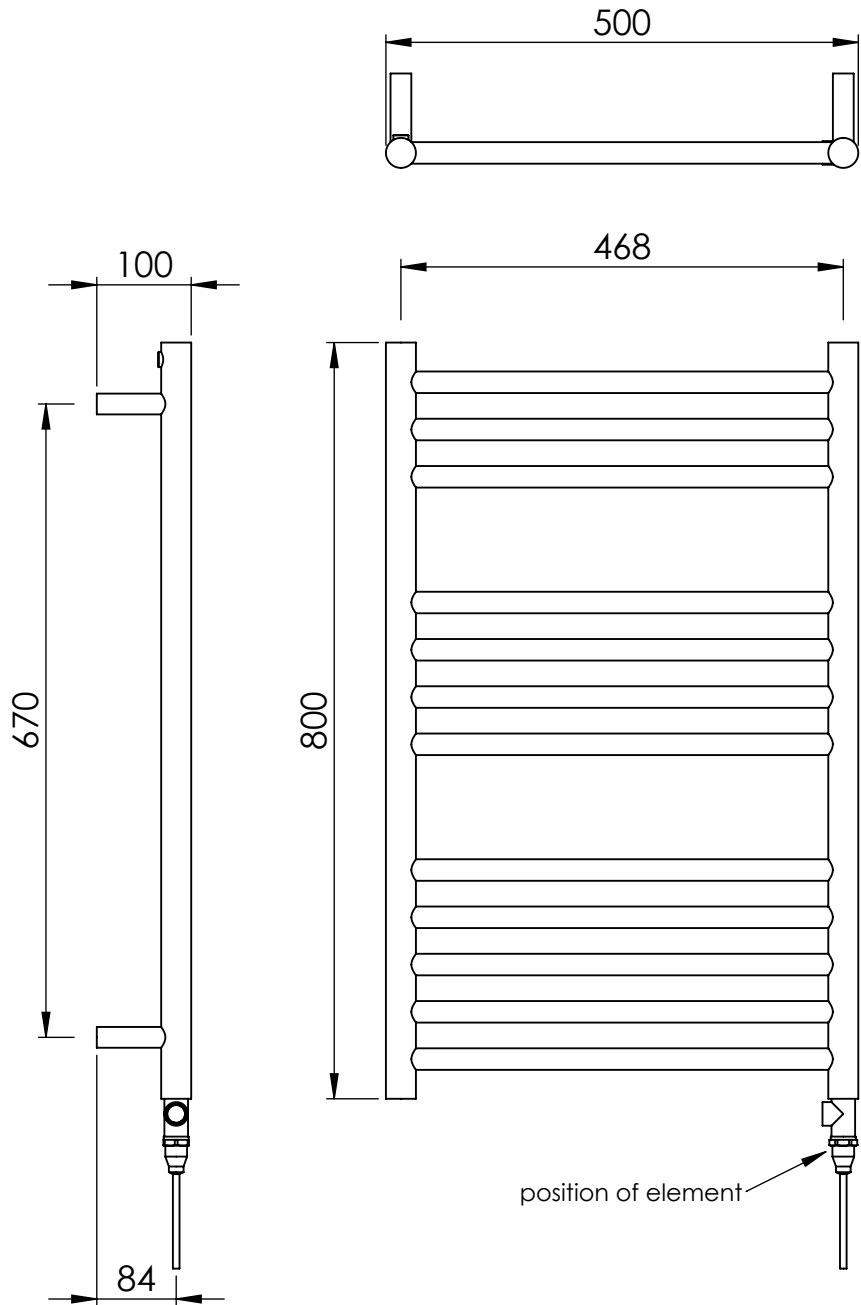
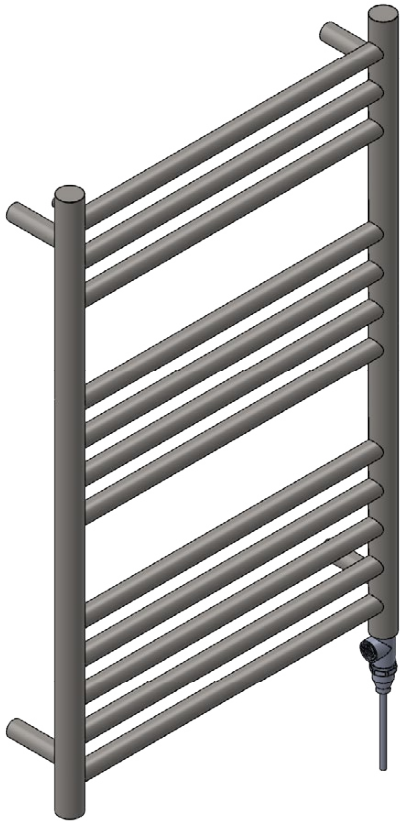

Narva Straight

All dimensions in millimetres

Manufactured from 1.4301/X5CrNi18-10 stainless steel

SCALE 1:8

E70196

Height: 800  
Width: 600  
Depth: 100

Tube  $\phi$  : 31.8 + 22  
Pipe Centres / Face-Face Cons: 568  
Output @ 50° C $\Delta$  T Watts: 269 W  
BTUs: 918 W

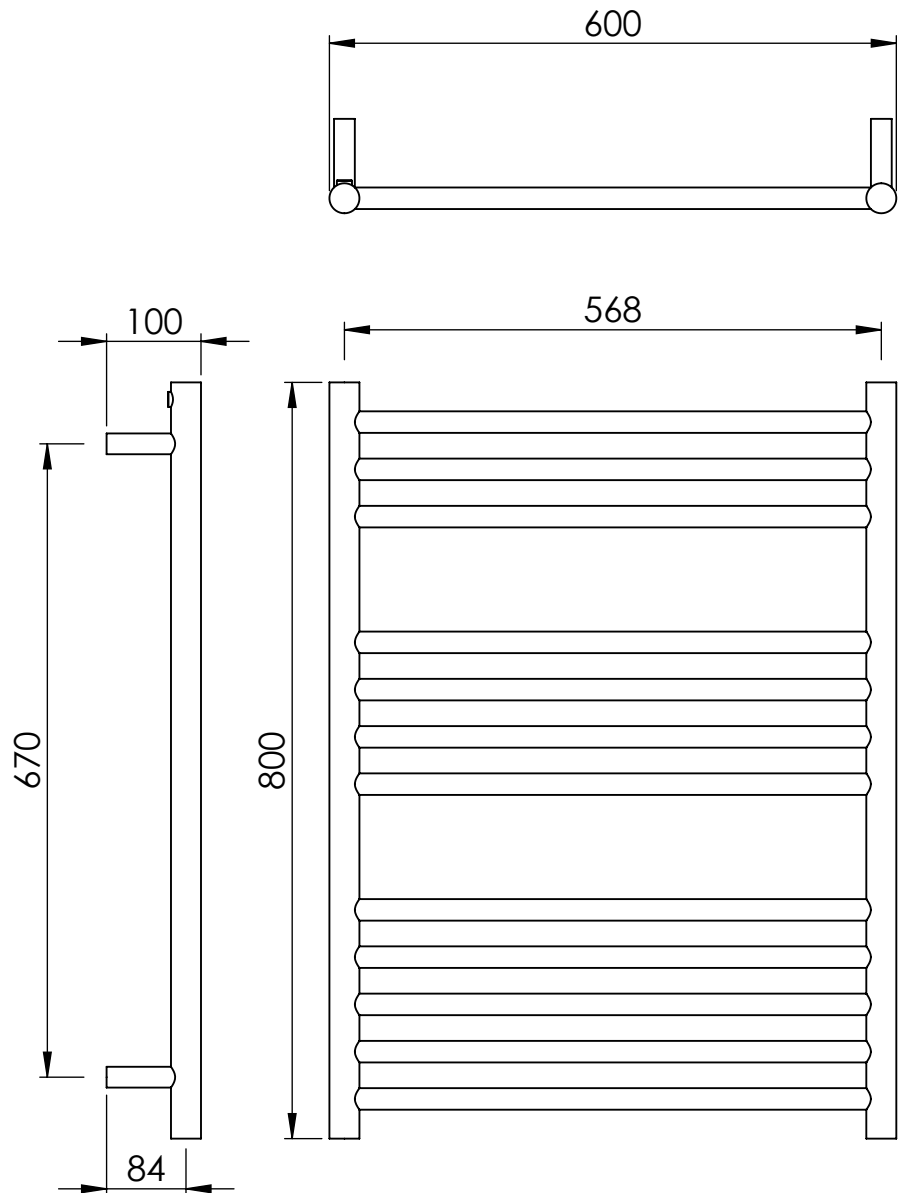
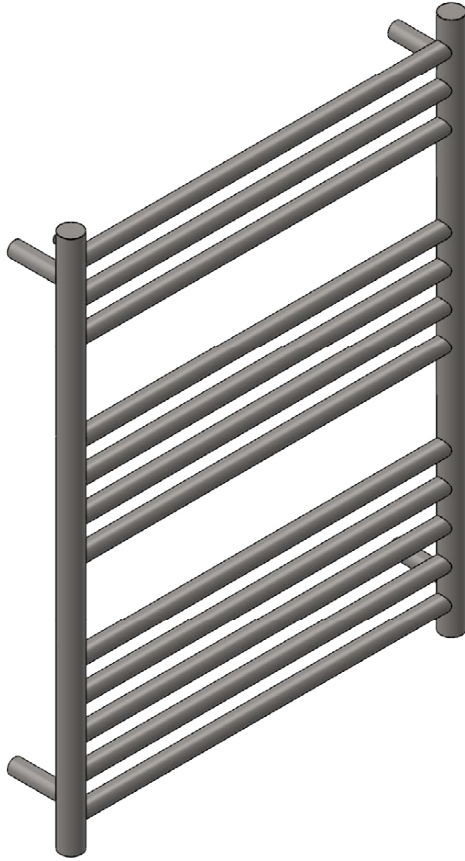

Narva Straight

All dimensions in millimetres

Manufactured from 1.4301/X5CrNi18-10 stainless steel

SCALE 1:8

E70197

Height: 800  
Width: 600  
Depth: 100

Tube  $\phi$  : 31.8 + 22  
Pipe Centres / Face-Face Cons: 568  
Elec. element if specified: 150 W

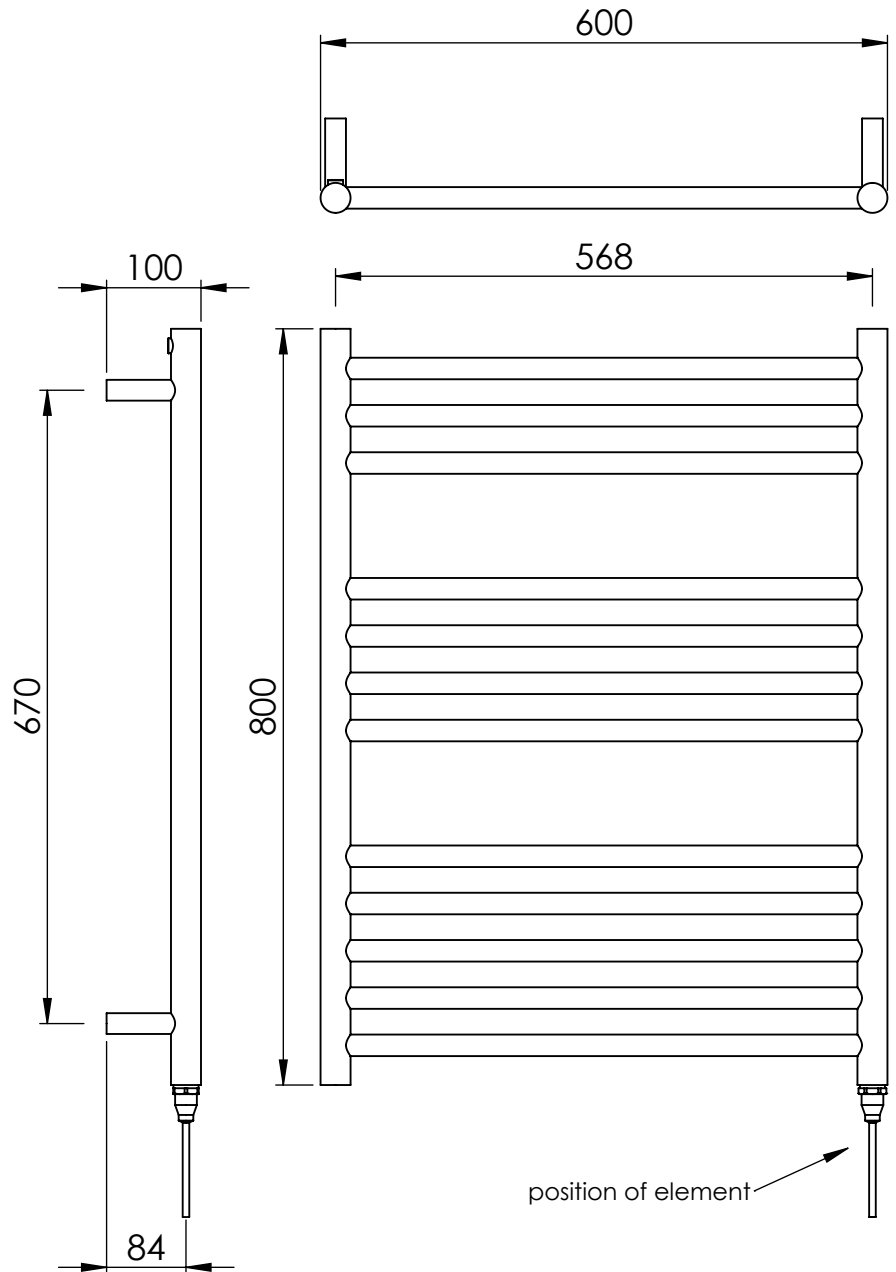
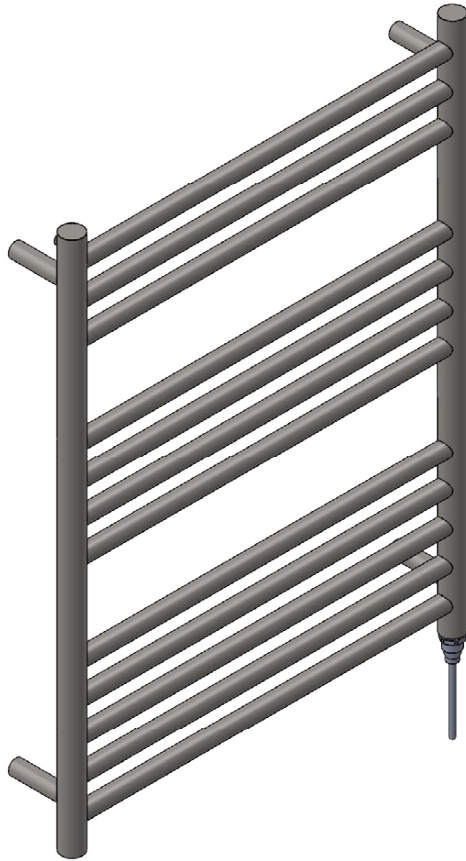

**esteem**<sup>®</sup>  
bathrooms

Narva Straight

All dimensions in millimetres

Manufactured from 1.4301/X5CrNi18-10 stainless steel

SCALE 1:8



E70198

Height: 800  
Width: 600  
Depth: 100

Tube  $\phi$  : 31.8 + 22  
Pipe Centres / Face-Face Cons: 568  
Elec. element if specified: 150 W  
Output @ 50° C  $\Delta$  T Watts: 269 W  
BTUs: 918 W

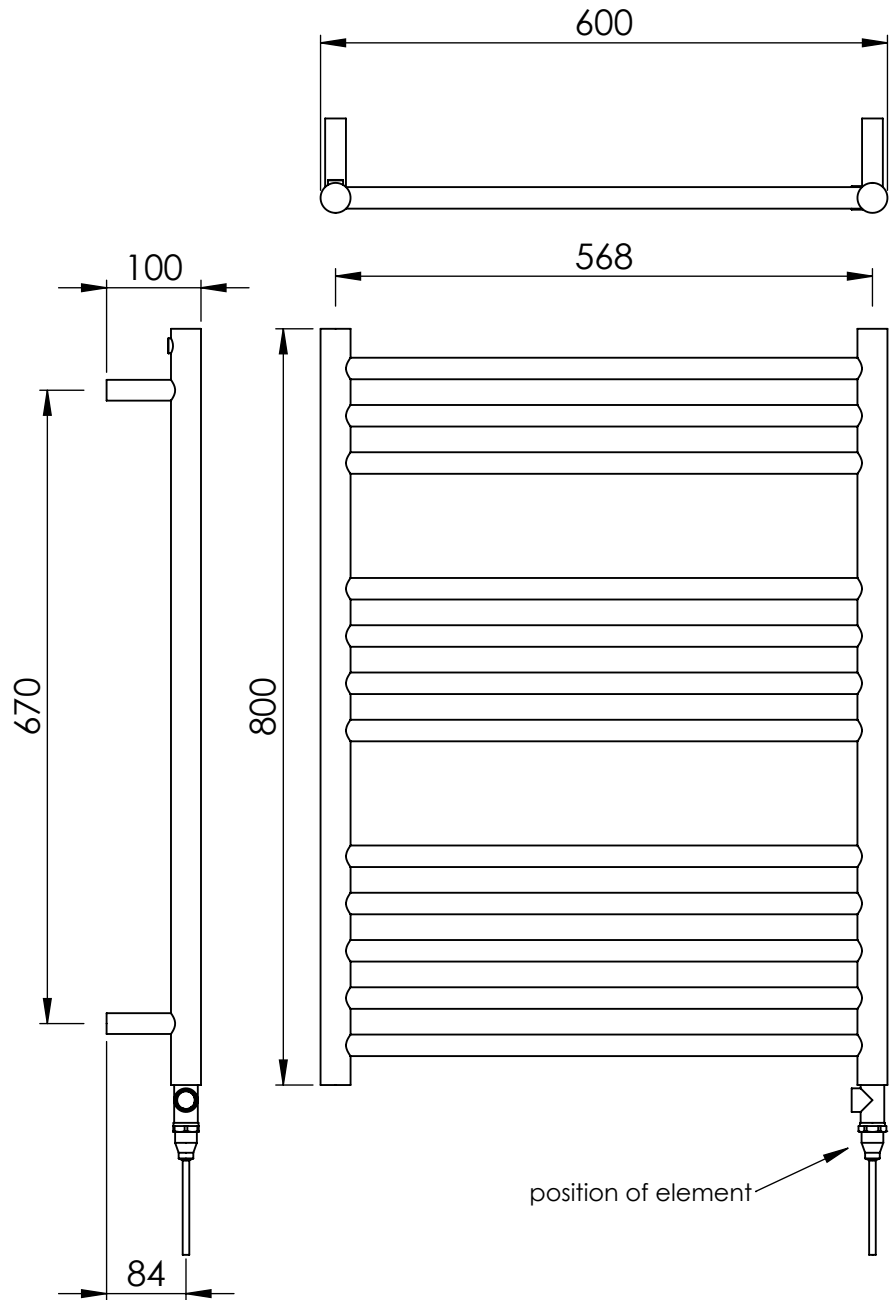
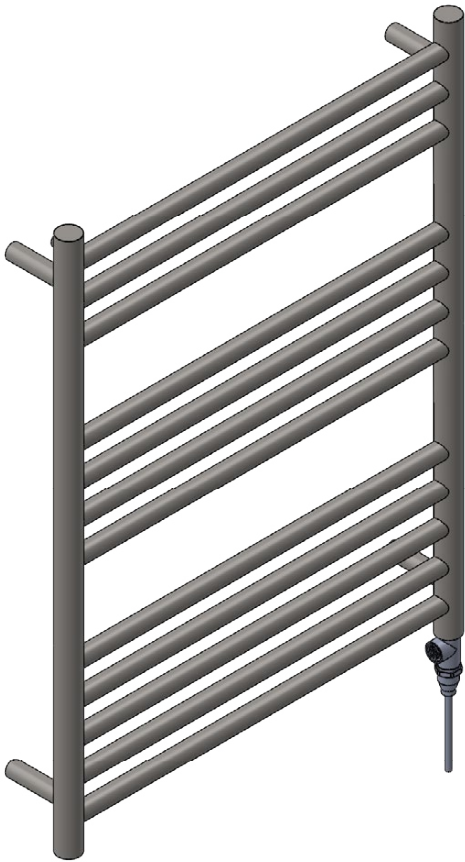

**esteem**<sup>®</sup>  
bathrooms

Narva Straight

All dimensions in millimetres

Manufactured from 1.4301/X5CrNi18-10 stainless steel

SCALE 1:8

# E70199

Height: 1200  
Width: 400  
Depth: 100

Tube  $\phi$  : 31.8 + 22  
Pipe Centres / Face-Face Cons: 368  
Output @ 50° C  $\Delta$  T Watts: 294 W  
BTUs: 1003 W

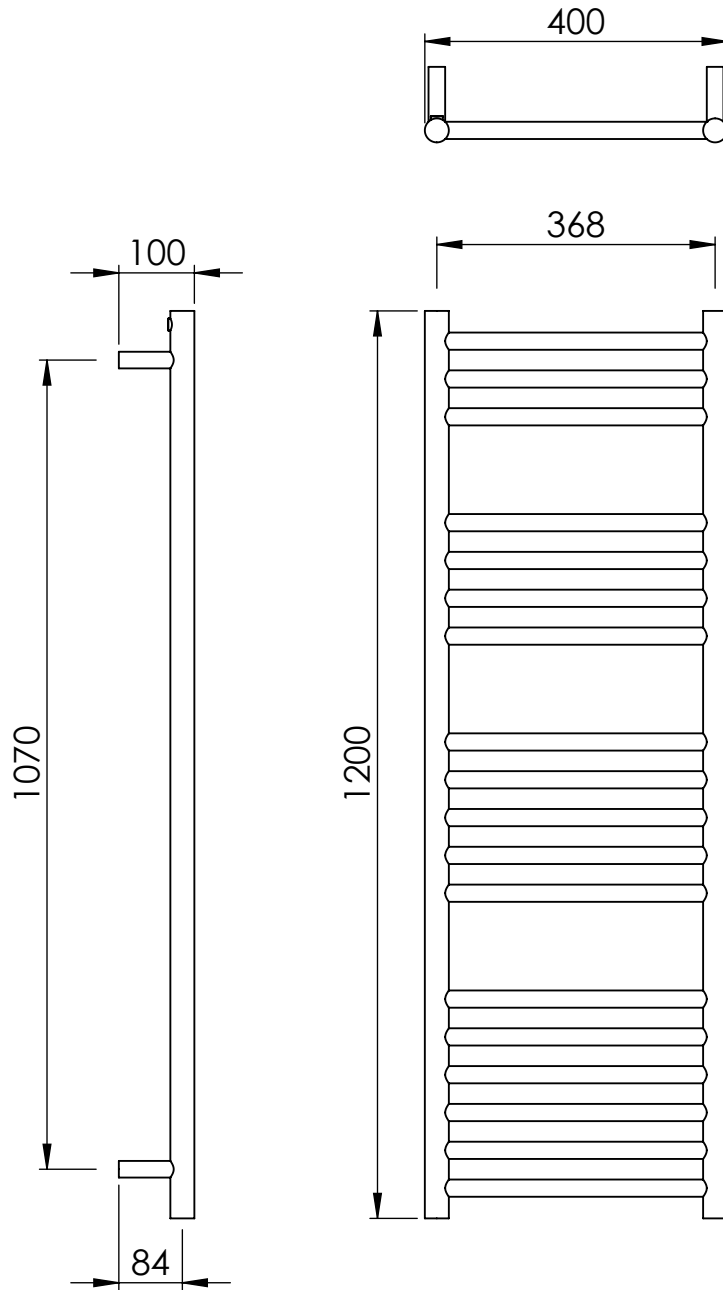
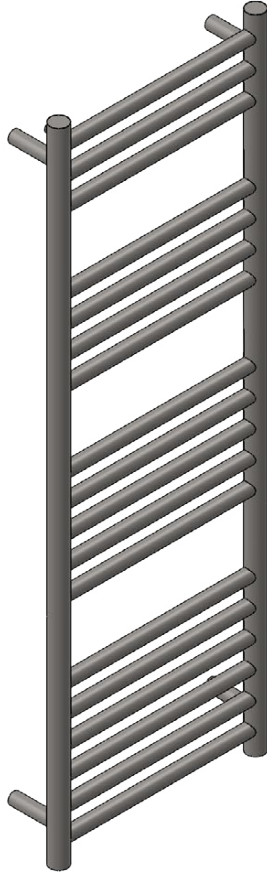

**esteem**<sup>®</sup>  
bathrooms

Narva Straight

All dimensions in millimetres

Manufactured from 1.4301/X5CrNi18-10 stainless steel

SCALE 1:10

# E70200

Height: 1200  
Width: 400  
Depth: 100

Tube  $\phi$  : 31.8 + 22  
Pipe Centres / Face-Face Cons: 368  
Elec. element if specified: 150 W

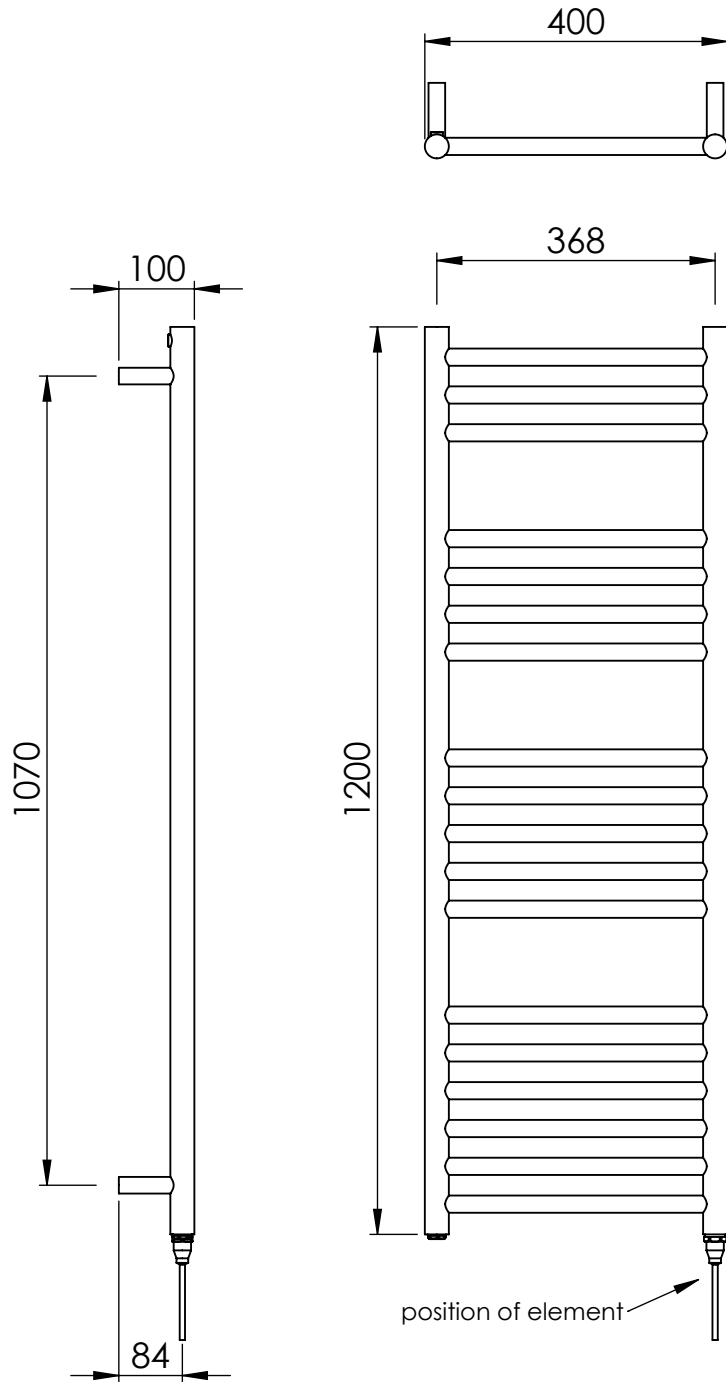
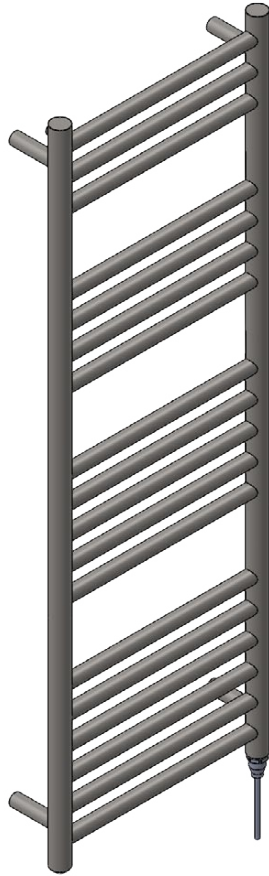

**esteem**<sup>®</sup>  
bathrooms

Narva Straight

All dimensions in millimetres

Manufactured from 1.4301/X5CrNi18-10 stainless steel

SCALE 1:10

# E70201

Height: 1200  
Width: 400  
Depth: 100

Tube  $\phi$  : 31.8 + 22  
Pipe Centres / Face-Face Cons: 368  
Elec. element if specified: 150 W  
Output @ 50° C  $\Delta$  T Watts: 294 W  
BTUs: 1003 W

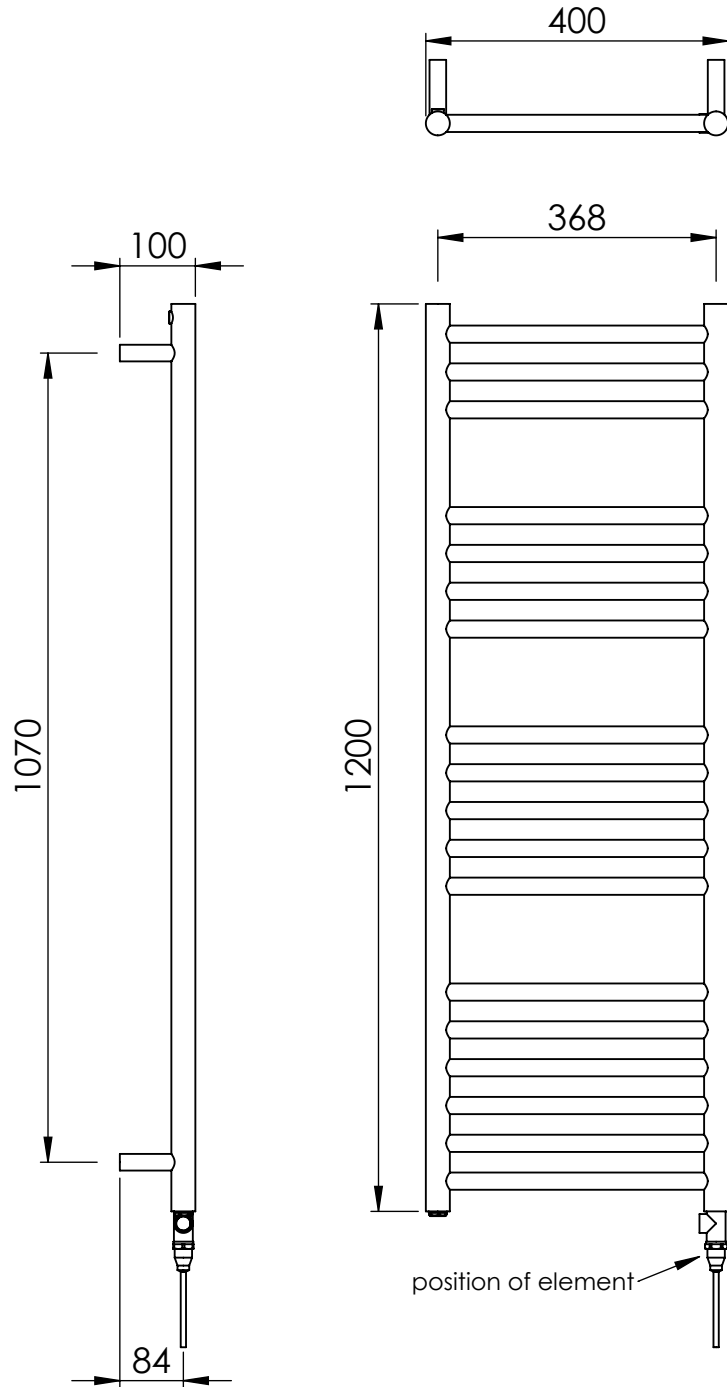
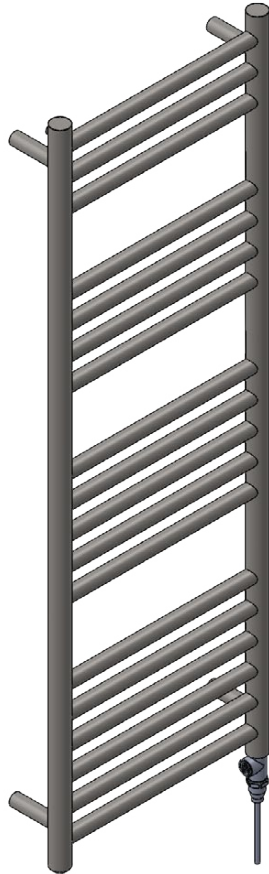

Narva Straight

All dimensions in millimetres

Manufactured from 1.4301/X5CrNi18-10 stainless steel

SCALE 1:10

E70202

Height: 1200  
Width: 500  
Depth: 100

Tube  $\phi$  : 31.8 + 22  
Pipe Centres / Face-Face Cons: 468  
Output @ 50° C  $\Delta$  T Watts: 348 W  
BTUs: 1187 W

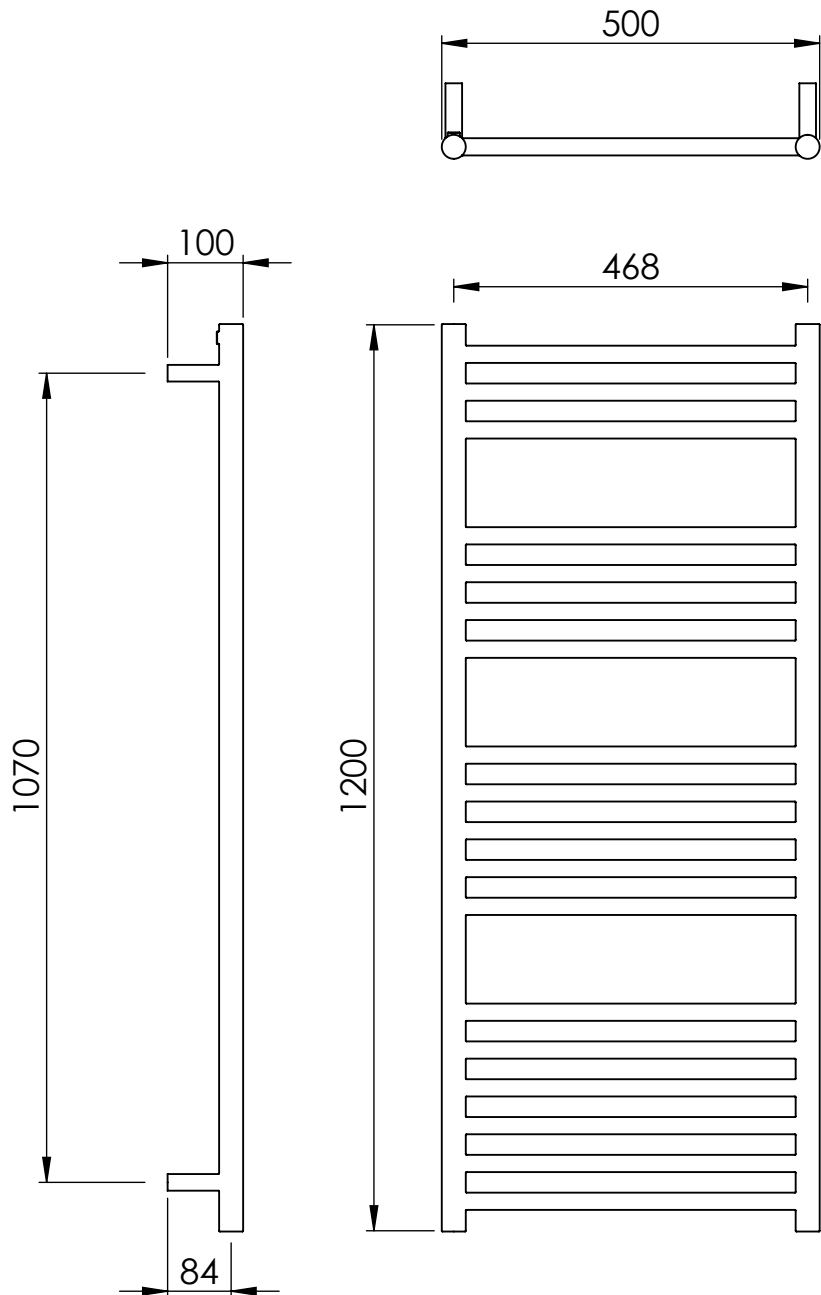
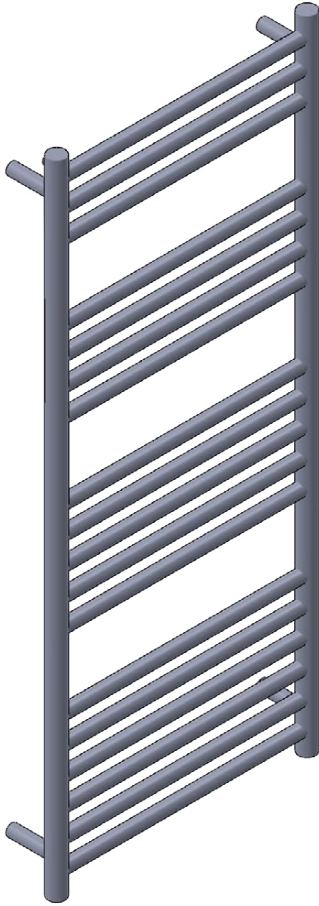

Narva Straight

All dimensions in millimetres

Manufactured from 1.4301/X5CrNi18-10 stainless steel

SCALE 1:10

E70203

Height: 1200  
Width: 500  
Depth: 100

Tube  $\phi$  : 31.8 + 22  
Pipe Centres / Face-Face Cons: 468  
Elec. element if specified: 200 W

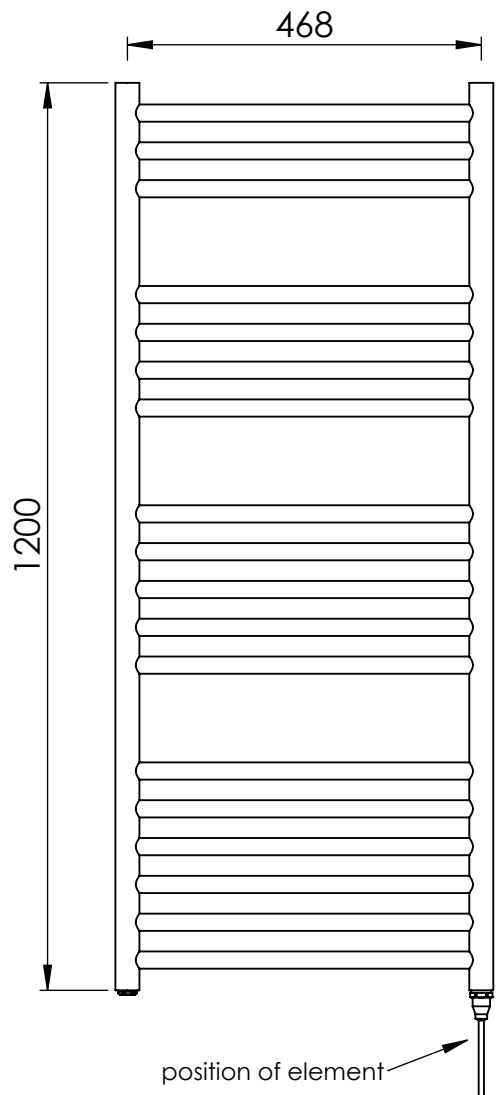
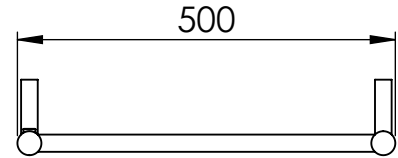
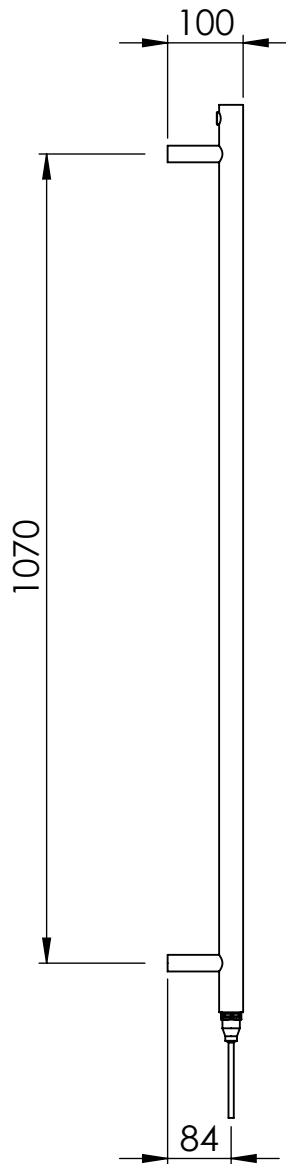
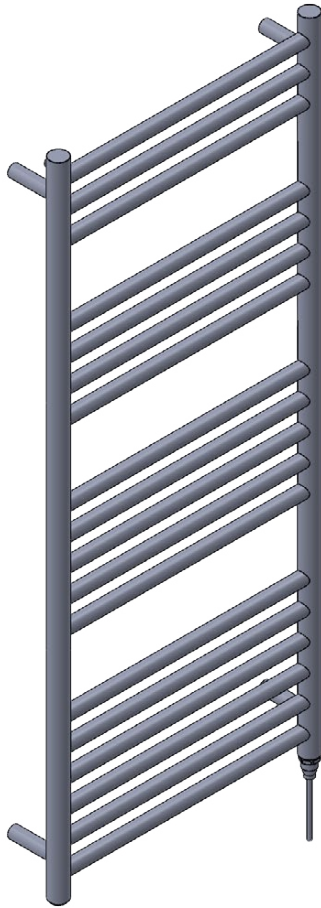

Narva Straight

All dimensions in millimetres

Manufactured from 1.4301/X5CrNi18-10 stainless steel

SCALE 1:10

E70204

Height: 1200  
Width: 500  
Depth: 100

Tube  $\phi$  : 31.8 + 22  
Pipe Centres / Face-Face Cons: 468  
Elec. element if specified: 200 W  
Output @ 50° C  $\Delta$  T Watts: 348 W  
BTUs: 1187 W

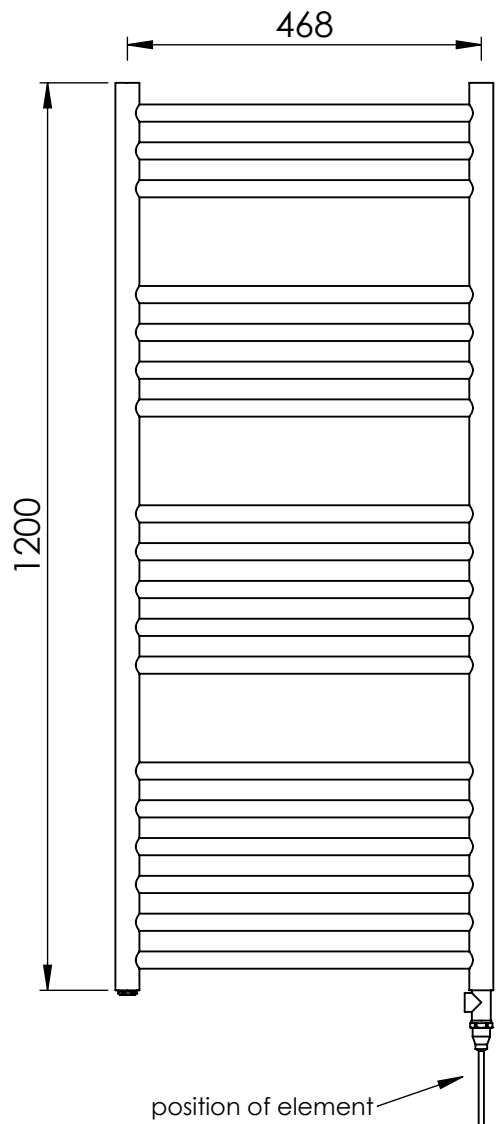
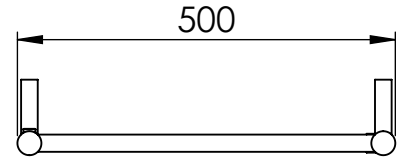
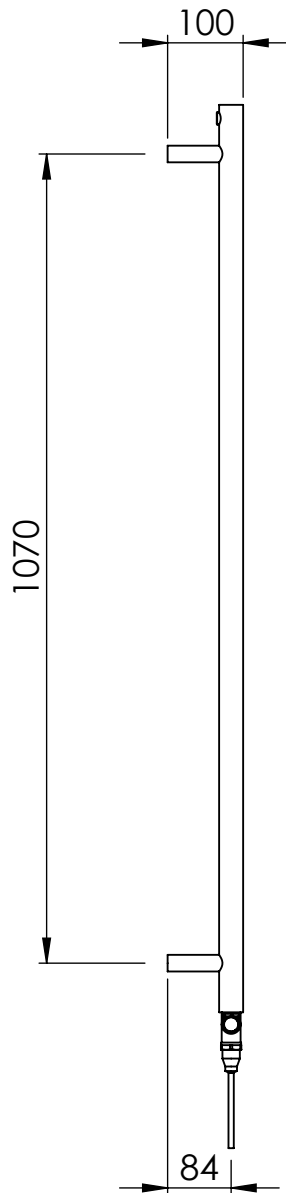
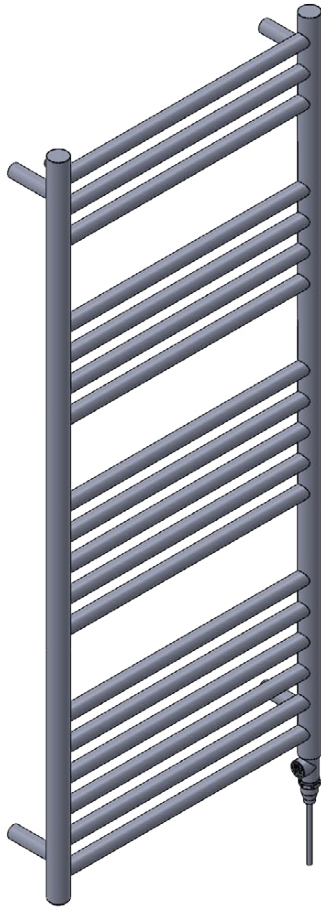

Narva Straight

All dimensions in millimetres

Manufactured from 1.4301/X5CrNi18-10 stainless steel

SCALE 1:10

E70205

Height: 1200  
Width: 600  
Depth: 100

Tube  $\phi$  : 31.8 + 22  
Pipe Centres / Face-Face Cons: 568  
Output @ 50° C  $\Delta$  T Watts: 402 W  
BTUs: 1372 W

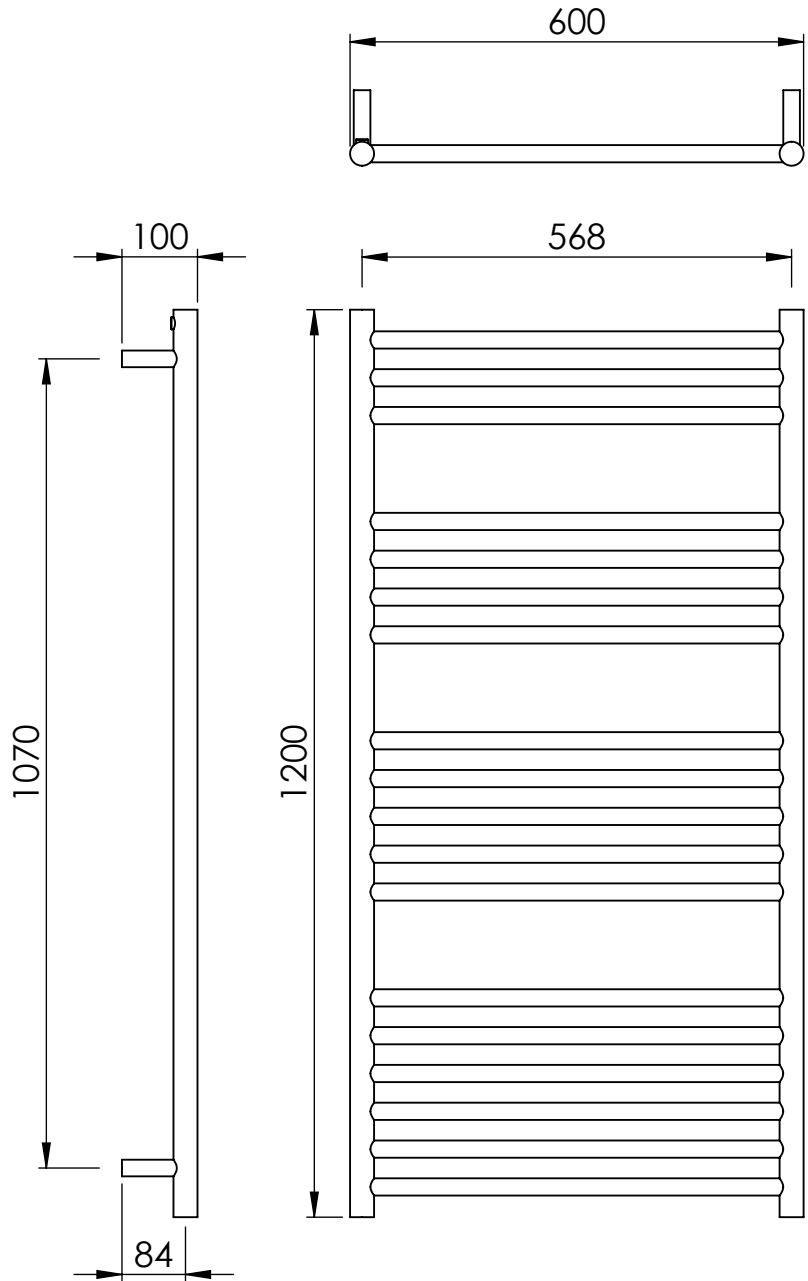
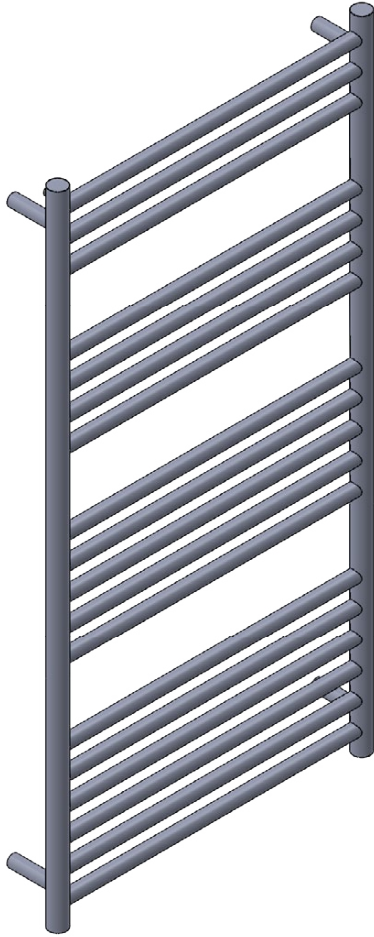

Narva Straight

All dimensions in millimetres

Manufactured from 1.4301/X5CrNi18-10 stainless steel

SCALE 1:10



E70206

Height: 1200  
Width: 600  
Depth: 100

Tube  $\phi$  : 31.8 + 22  
Pipe Centres / Face-Face Cons: 568  
Elec. element if specified: 200 W

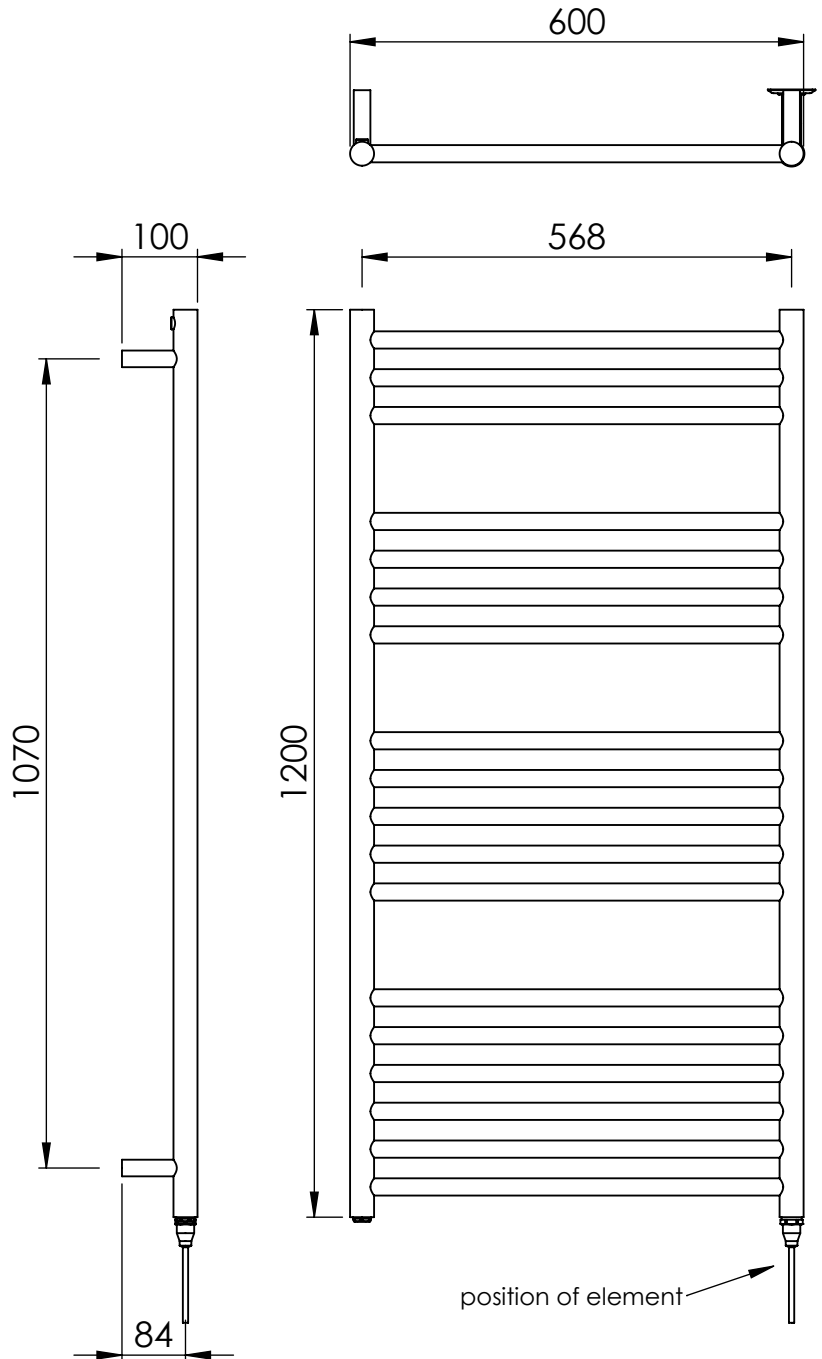
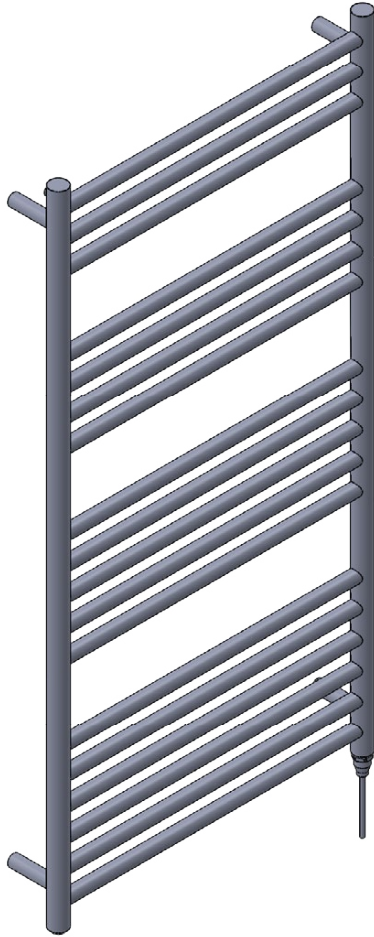

**esteem**<sup>®</sup>  
bathrooms

Narva Straight

All dimensions in millimetres

Manufactured from 1.4301/X5CrNi18-10 stainless steel

SCALE 1:10

E70207

Height: 1200  
Width: 600  
Depth: 100

Tube  $\phi$  : 31.8 + 22  
Pipe Centres / Face-Face Cons: 568  
Elec. element if specified: 200 W  
Output @ 50° C  $\Delta$  T Watts: 402 W  
BTUs: 1372 W

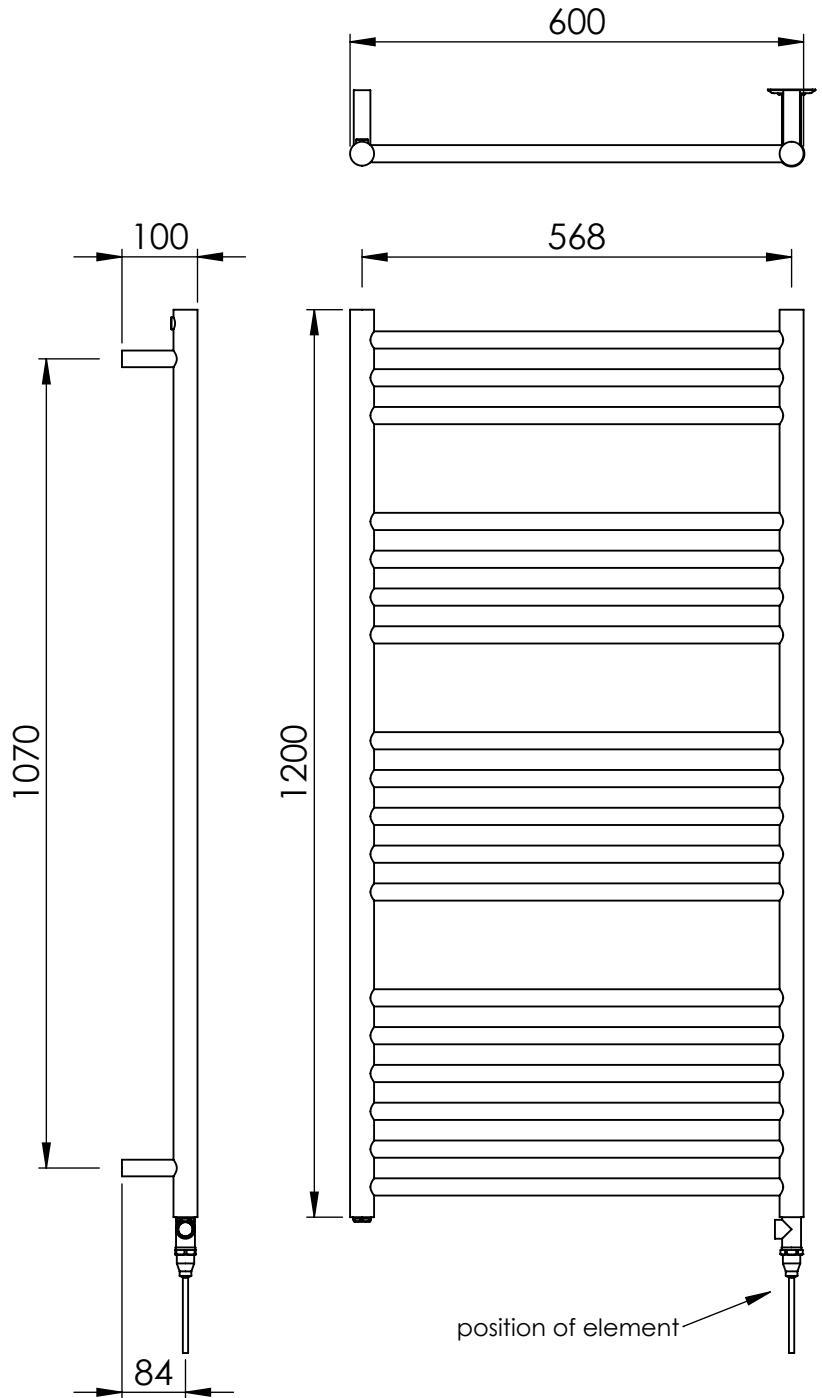
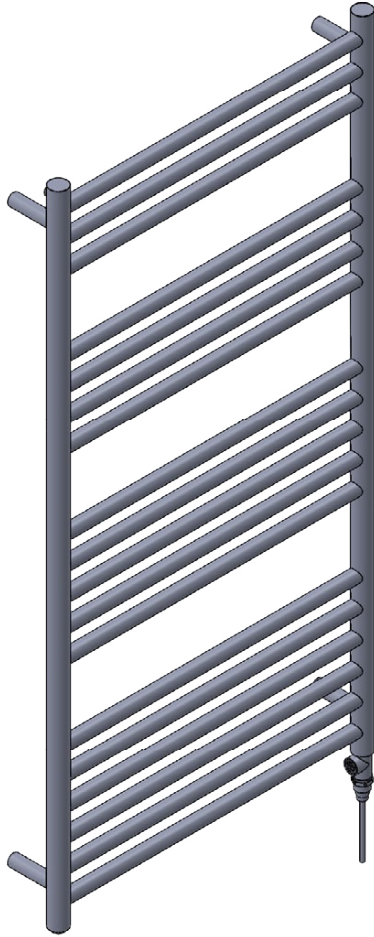

Narva Straight

All dimensions in millimetres

Manufactured from 1.4301/X5CrNi18-10 stainless steel

SCALE 1:10

E70208

Height: 1600  
Width: 400  
Depth: 100

Tube  $\phi$  : 31.8 + 22  
Pipe Centres / Face-Face Cons: 368  
Output @ 50° C  $\Delta$  T Watts: 391 W  
BTUs: 1334 W

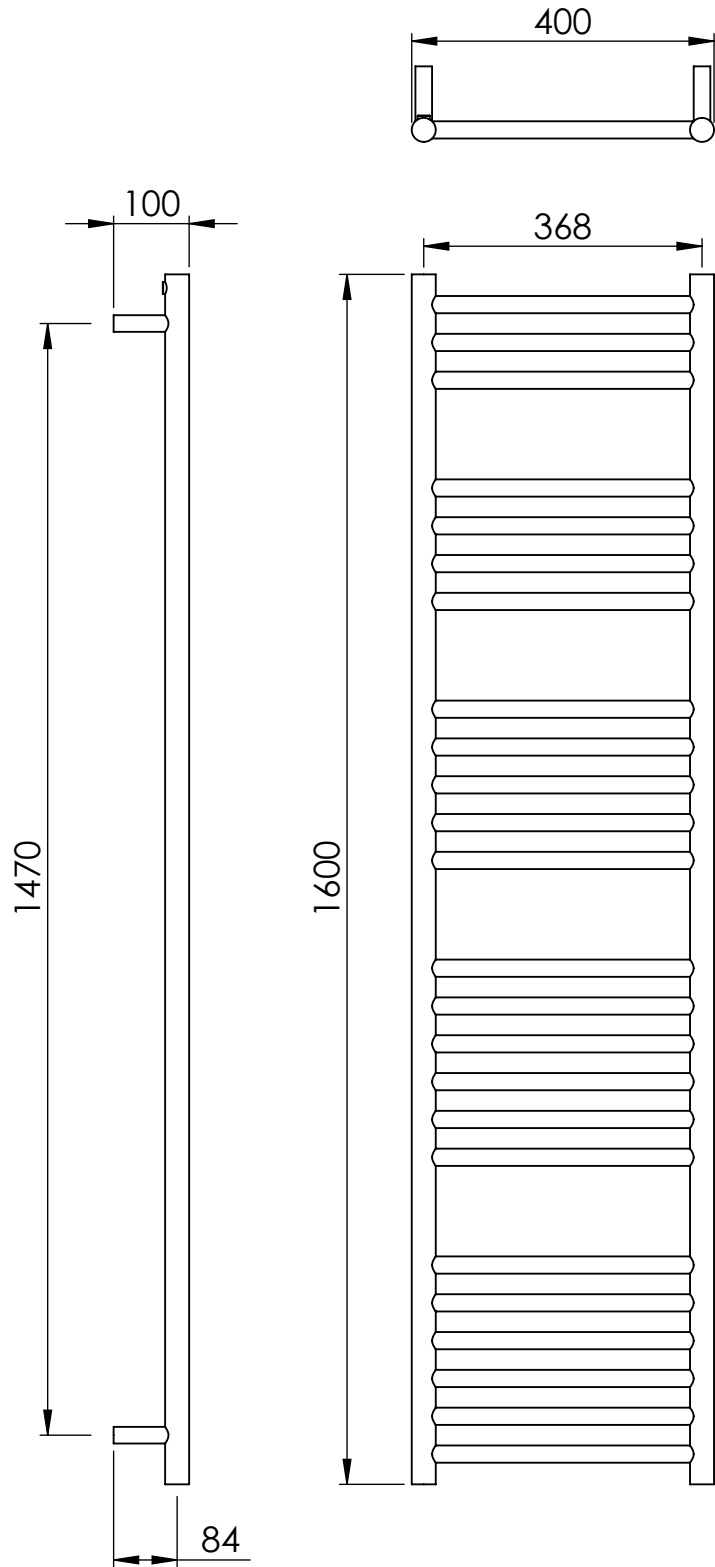
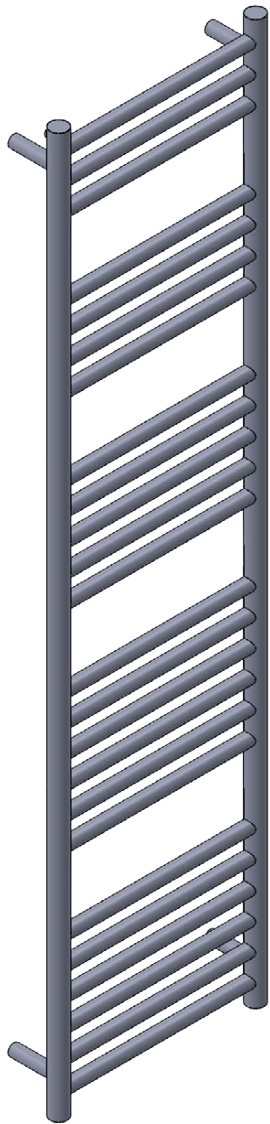

Narva Straight

All dimensions in millimetres

Manufactured from 1.4301/X5CrNi18-10 stainless steel

SCALE 1:10

E70209

Height: 1600  
Width: 400  
Depth: 100

Tube  $\phi$  : 31.8 + 22  
Pipe Centres / Face-Face Cons: 368  
Elec. element if specified: 200 W

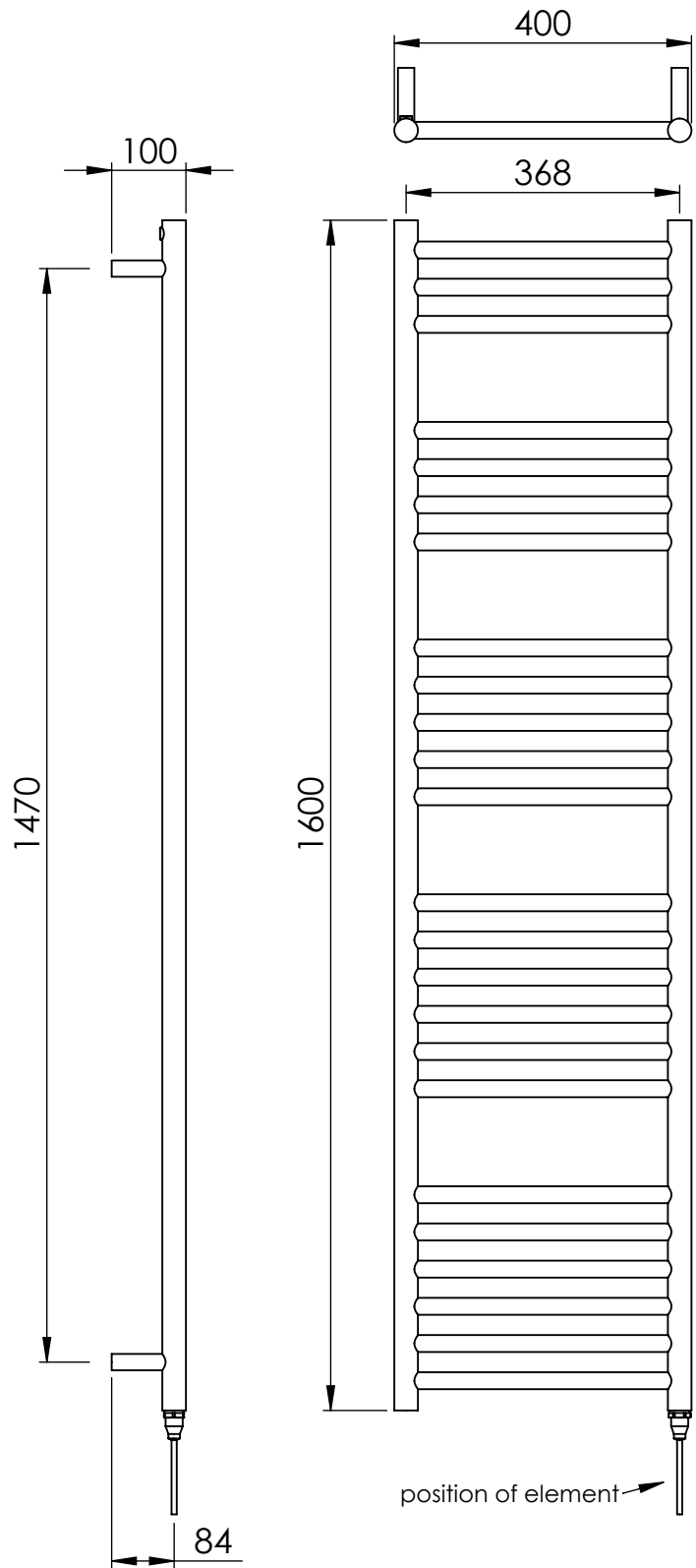
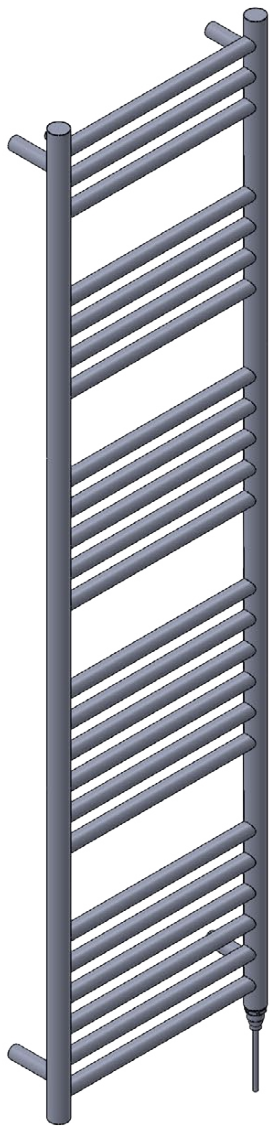

**esteem**<sup>®</sup>  
bathrooms

Narva Straight

All dimensions in millimetres

Manufactured from 1.4301/X5CrNi18-10 stainless steel

SCALE 1:10

E70210

Height: 1600  
Width: 400  
Depth: 100

Tube  $\phi$  : 31.8 + 22  
Pipe Centres / Face-Face Cons: 368  
Elec. element if specified: 200 W  
Output @ 50° C  $\Delta$  T Watts: 391 W  
BTUs: 1334 W

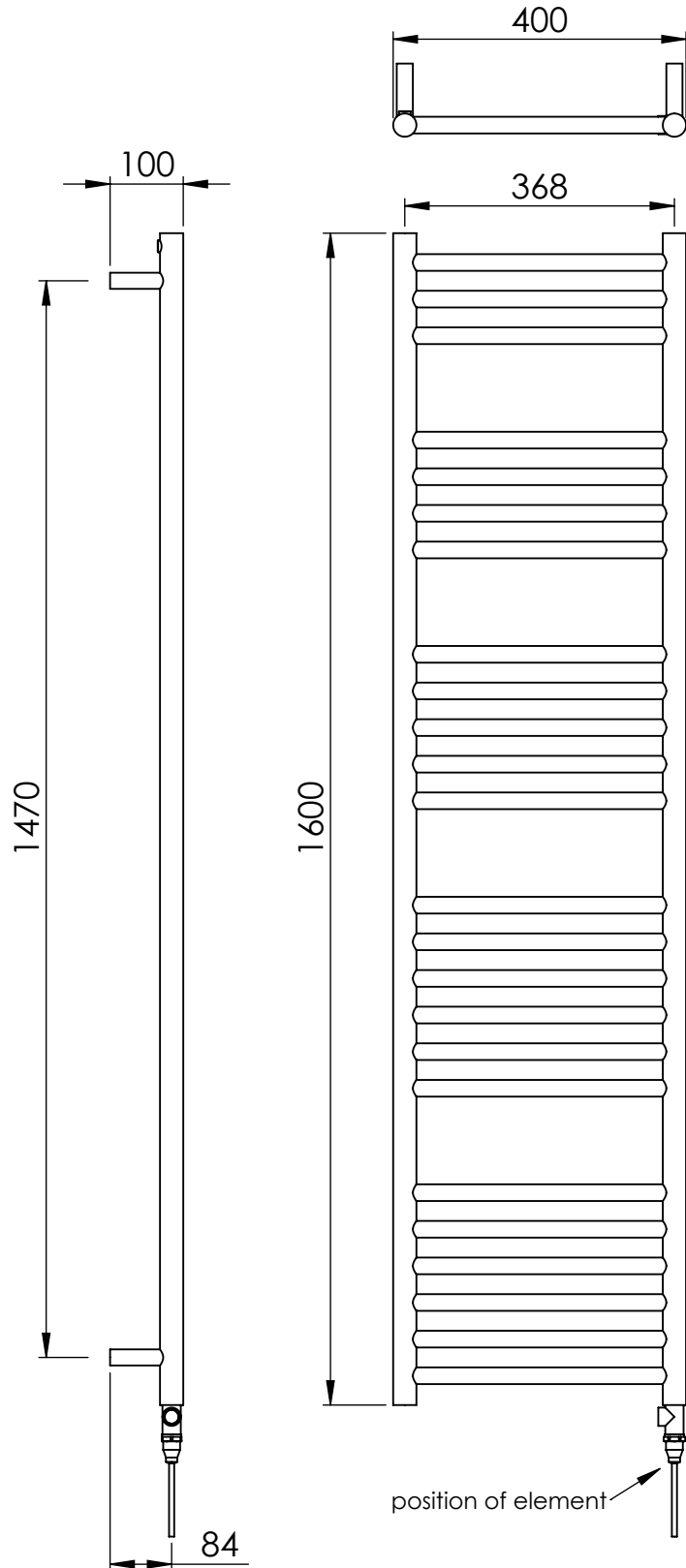
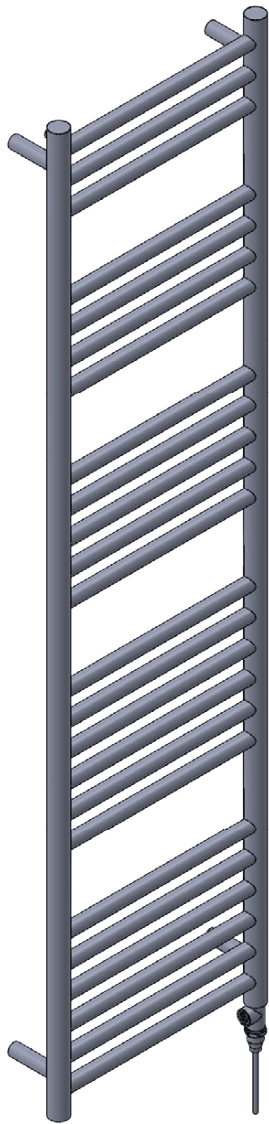

Narva Straight

All dimensions in millimetres

Manufactured from 1.4301/X5CrNi18-10 stainless steel

SCALE 1:10

E70211

Height: 1600  
Width: 500  
Depth: 100

Tube  $\phi$  : 31.8 +22  
Pipe Centres / Face-Face Cons: 468  
Output @ 50° C $\Delta$  T Watts: 464 W  
BTUs: 1583 W

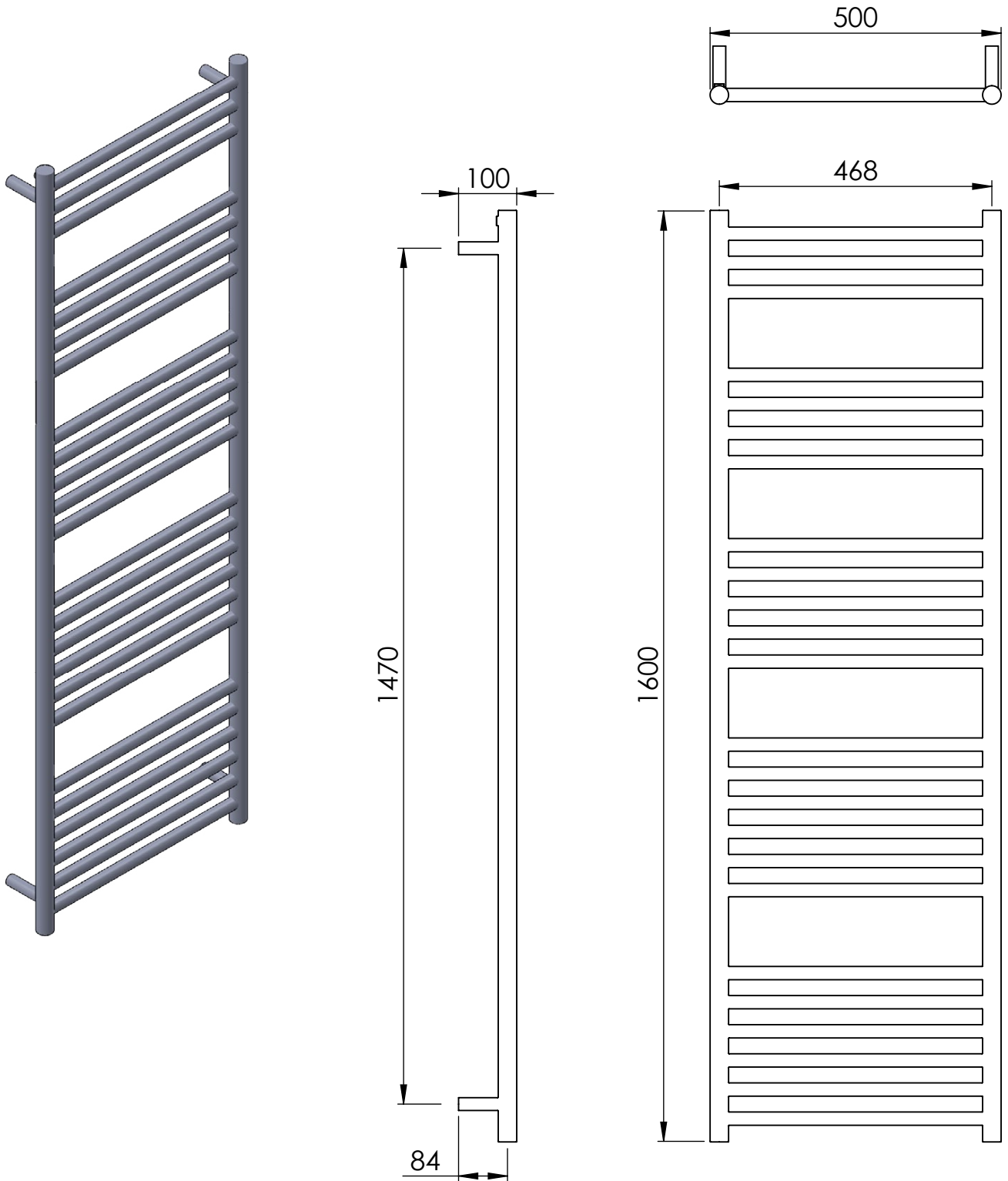

Narva Straight

All dimensions in millimetres

Manufactured from 1.4301/X5CrNi18-10 stainless steel

SCALE 1:10

E70212

Height: 1600  
Width: 500  
Depth: 100

Tube  $\phi$  : 31.8 +22  
Pipe Centres / Face-Face Cons: 468  
Elec. element if specified: 300 W

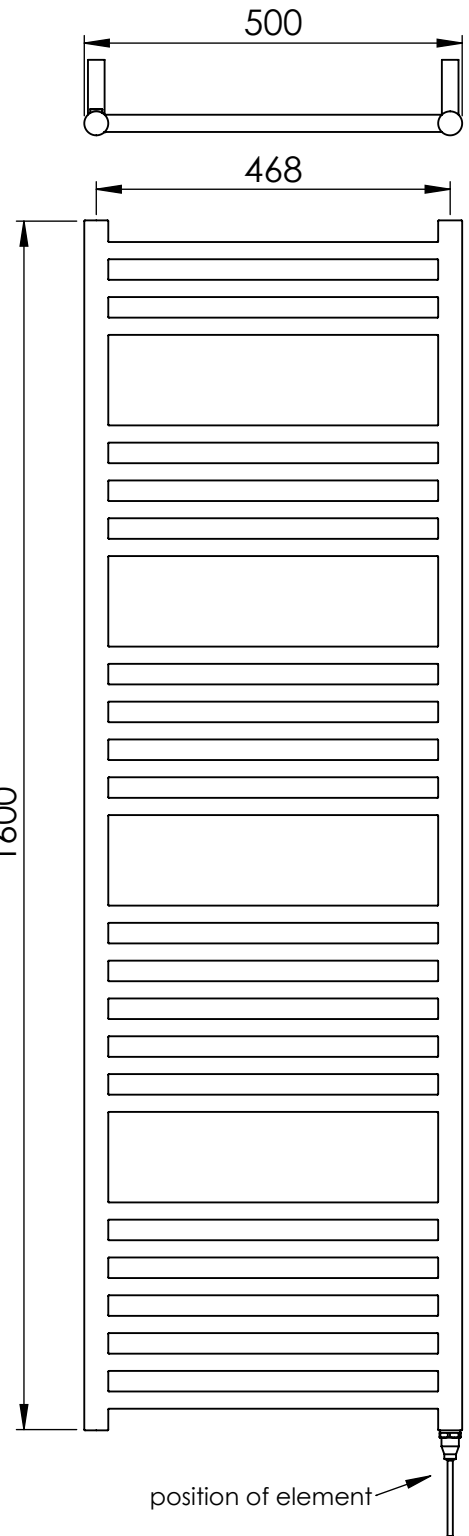
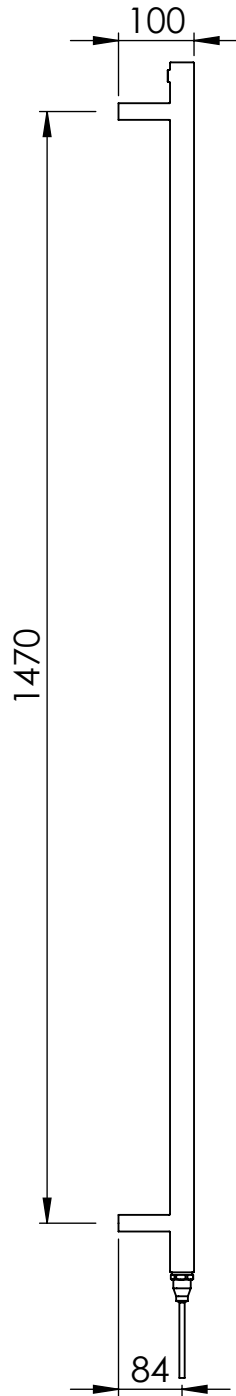
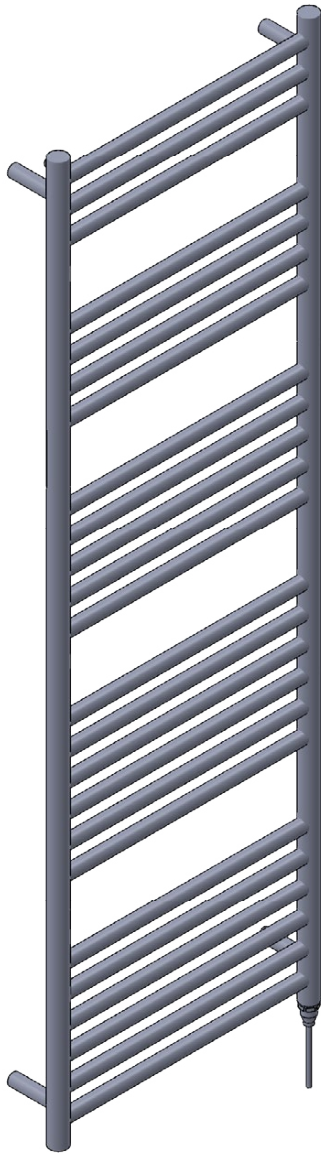

**esteem**<sup>®</sup>  
bathrooms

Narva Straight

All dimensions in millimetres

Manufactured from 1.4301/X5CrNi18-10 stainless steel

SCALE 1:10



E70213

Height: 1600  
Width: 500  
Depth: 100

Tube  $\phi$  : 31.8 +22  
Pipe Centres / Face-Face Cons: 468  
Elec. element if specified: 300 W  
Output @ 50° C  $\Delta$  T Watts: 464 W  
BTUs: 1583 W

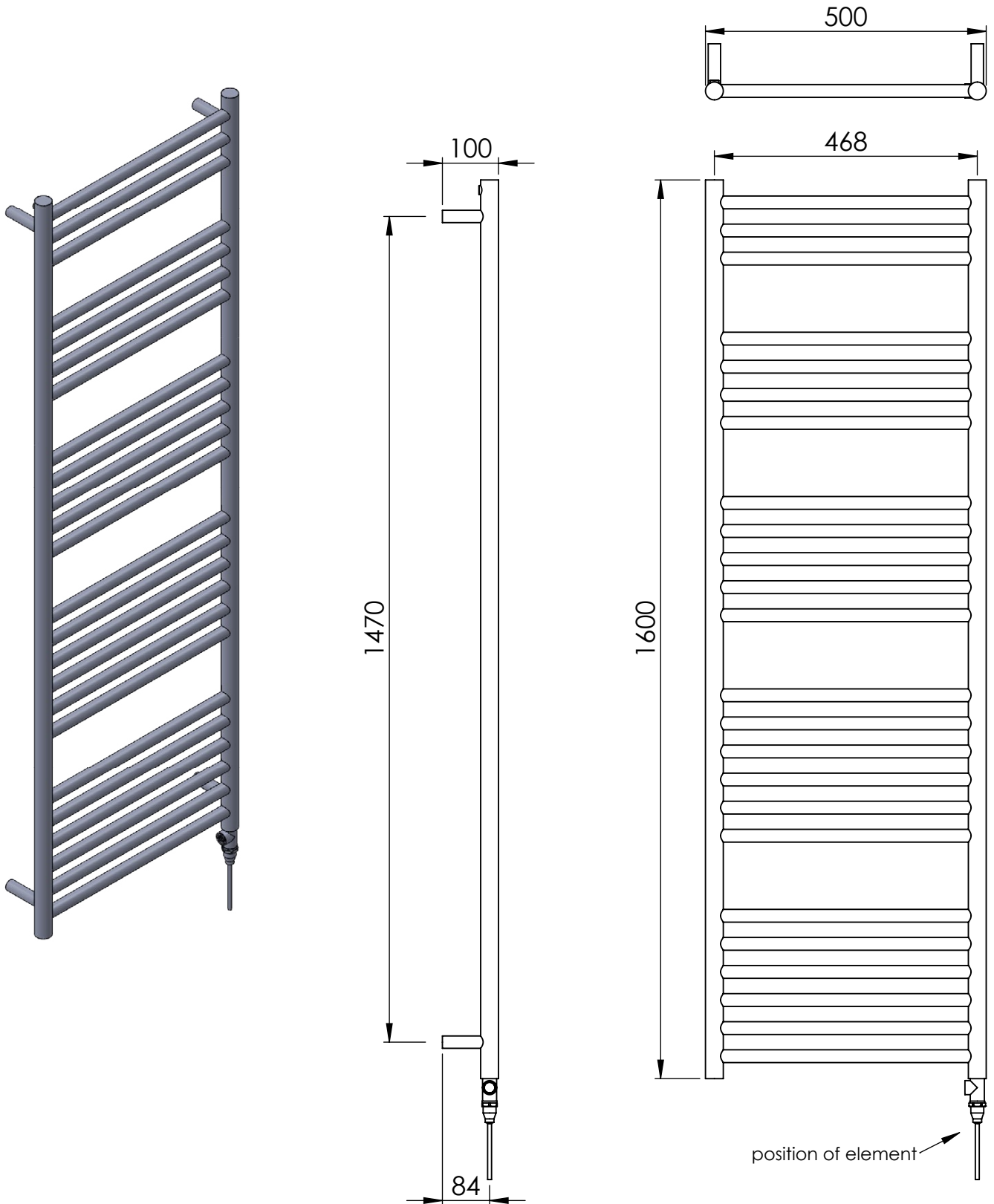

Narva Straight

All dimensions in millimetres

Manufactured from 1.4301/X5CrNi18-10 stainless steel

SCALE 1:10



E70214

Height: 1600  
Width: 600  
Depth: 100

Tube  $\phi$  : 31.8 + 22  
Pipe Centres / Face-Face Cons: 568  
Output @ 50° C  $\Delta$  T Watts: 536 W  
BTUs: 1829 W

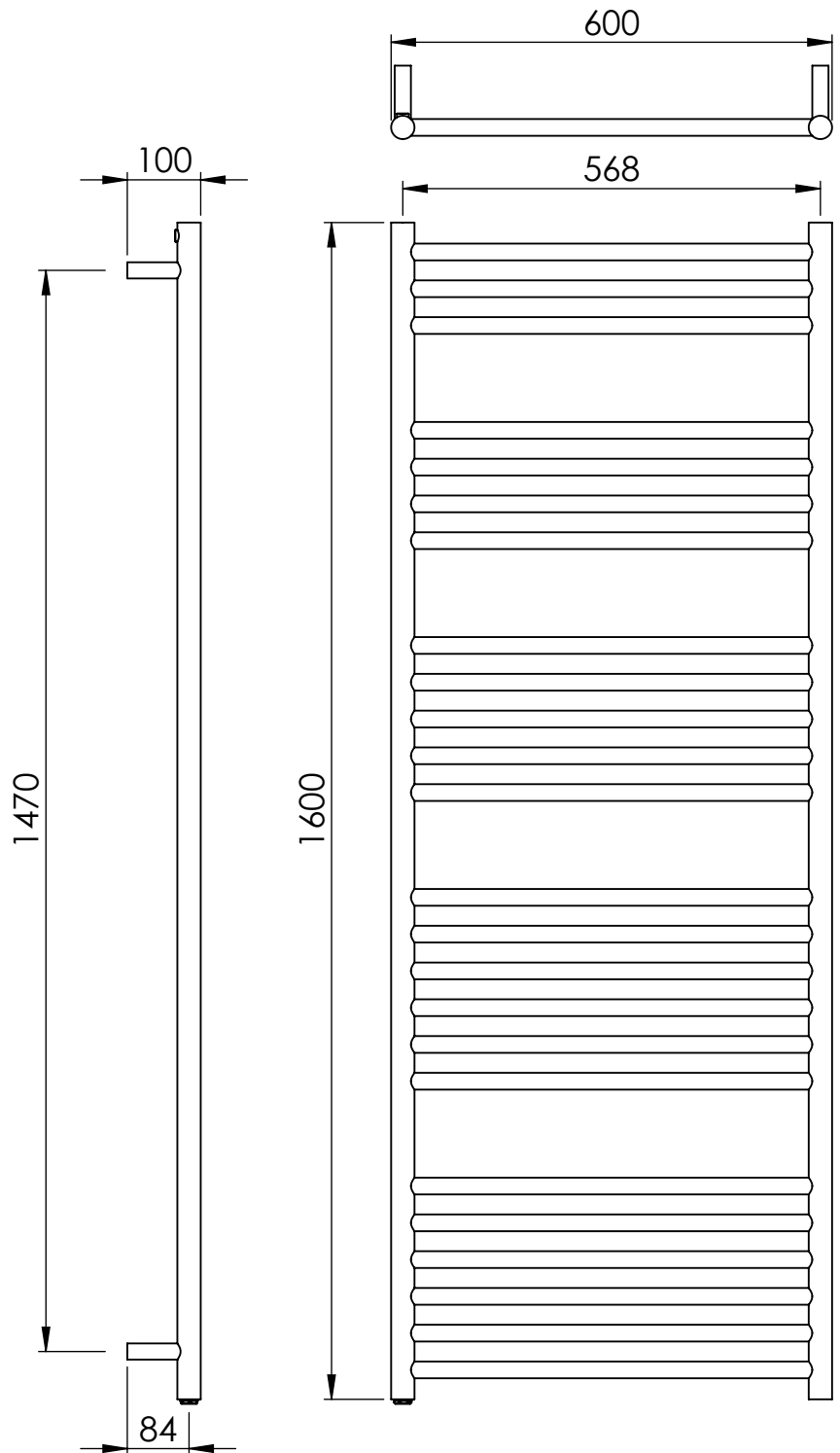
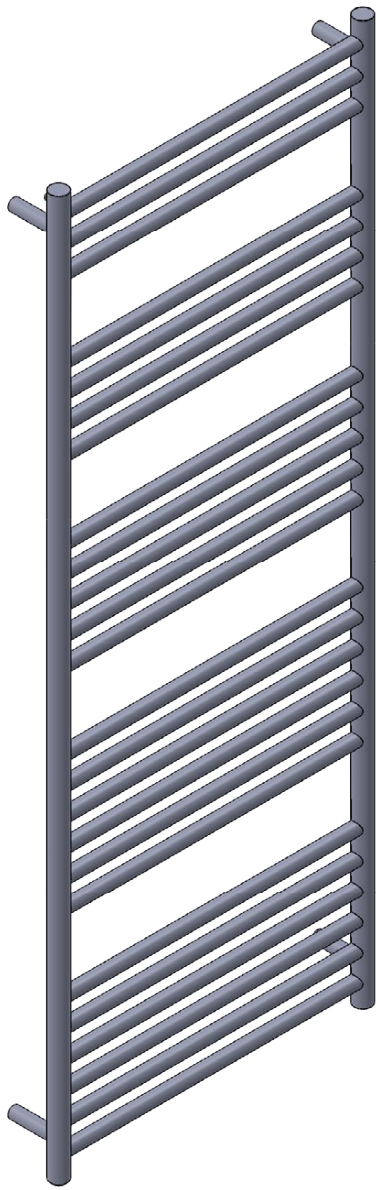

Narva Straight

All dimensions in millimetres

Manufactured from 1.4301/X5CrNi18-10 stainless steel

SCALE 1:10

E70215

Height: 1600  
Width: 600  
Depth: 100

Tube  $\phi$  : 31.8 + 22  
Pipe Centres / Face-Face Cons: 568  
Elec. element if specified: 300 W

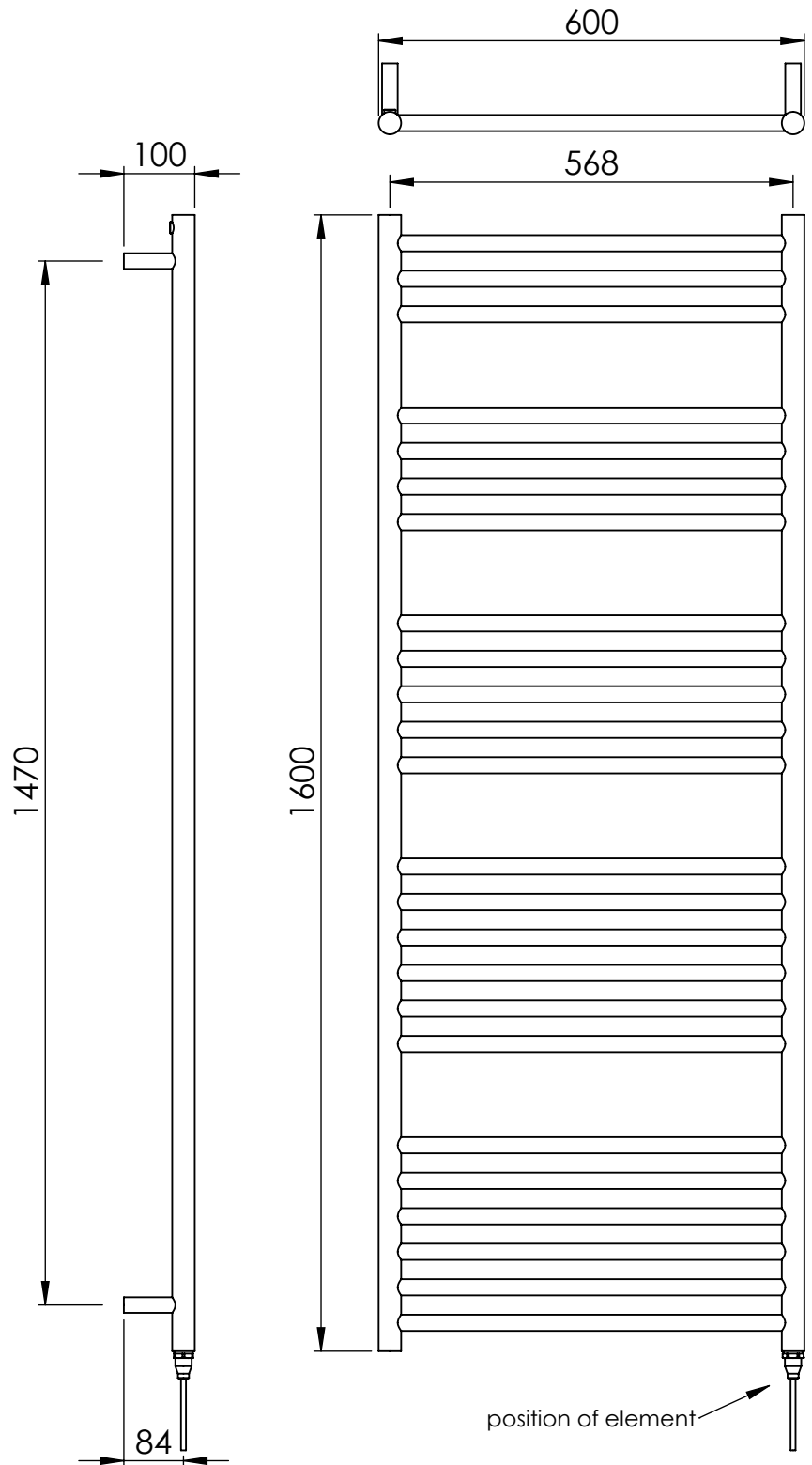
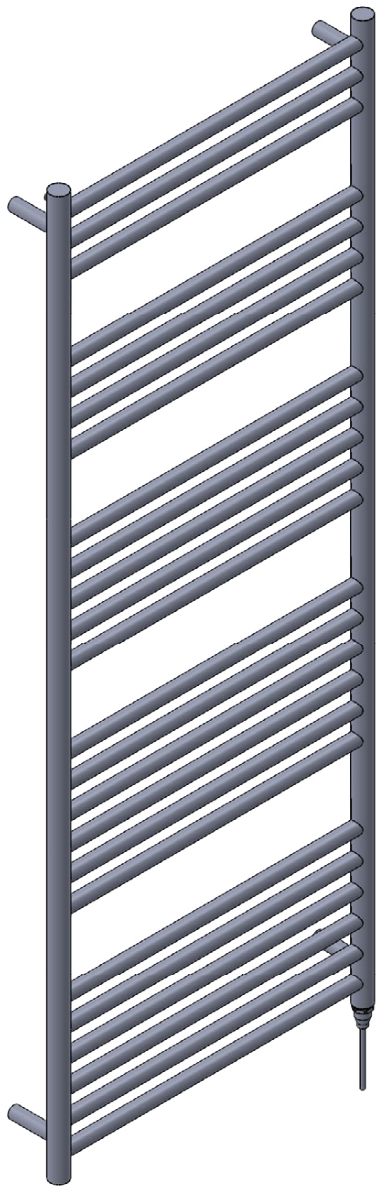

**esteem**<sup>®</sup>  
bathrooms

Narva Straight

All dimensions in millimetres

Manufactured from 1.4301/X5CrNi18-10 stainless steel

SCALE 1:10

# E70216

Height: 1600  
Width: 600  
Depth: 100

Tube  $\phi$  : 31.8 + 22  
Pipe Centres / Face-Face Cons: 568  
Elec. element if specified: 300 W  
Output @ 50° C  $\Delta$  T Watts: 536 W  
BTUs: 1829 W

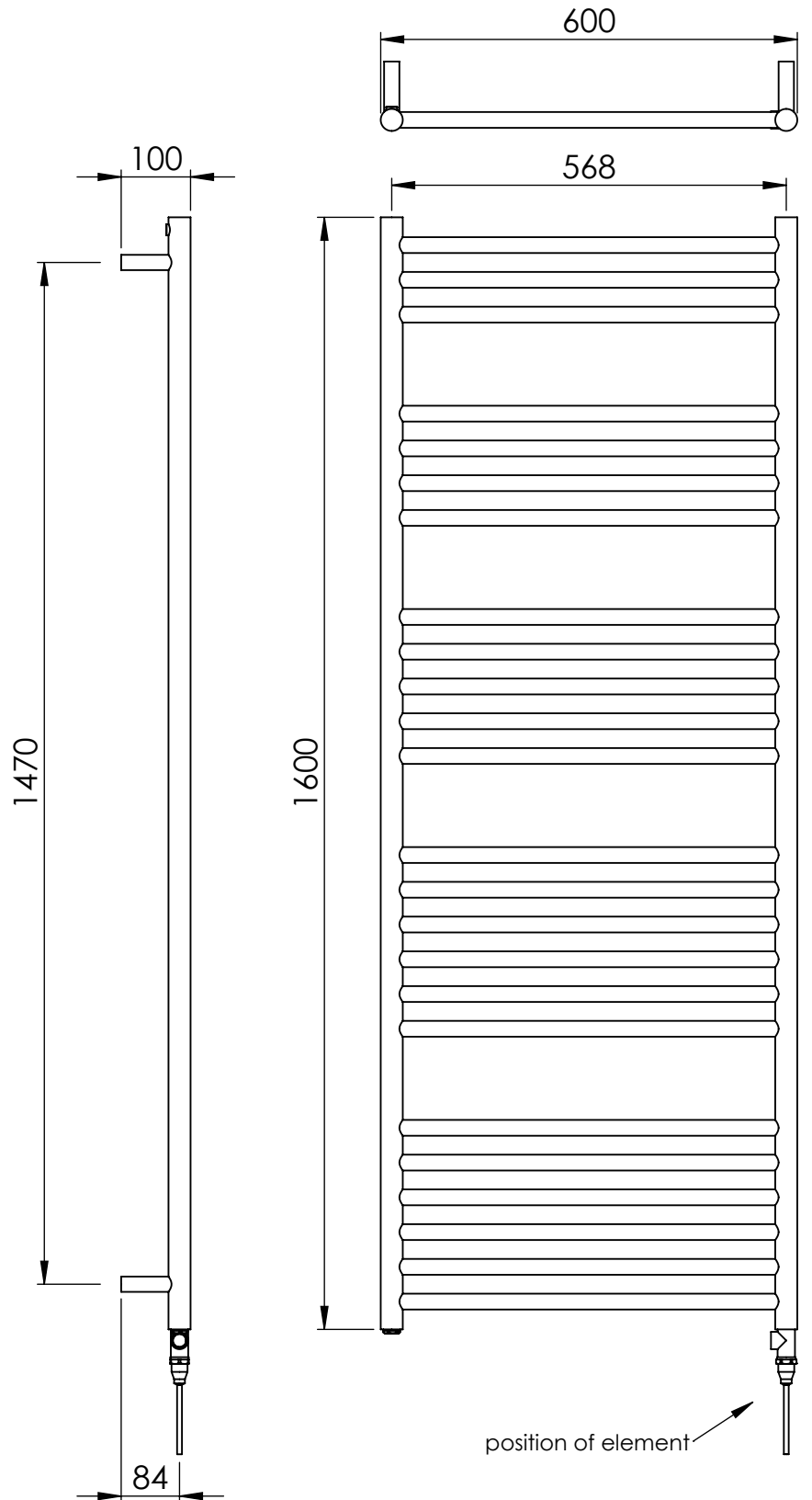
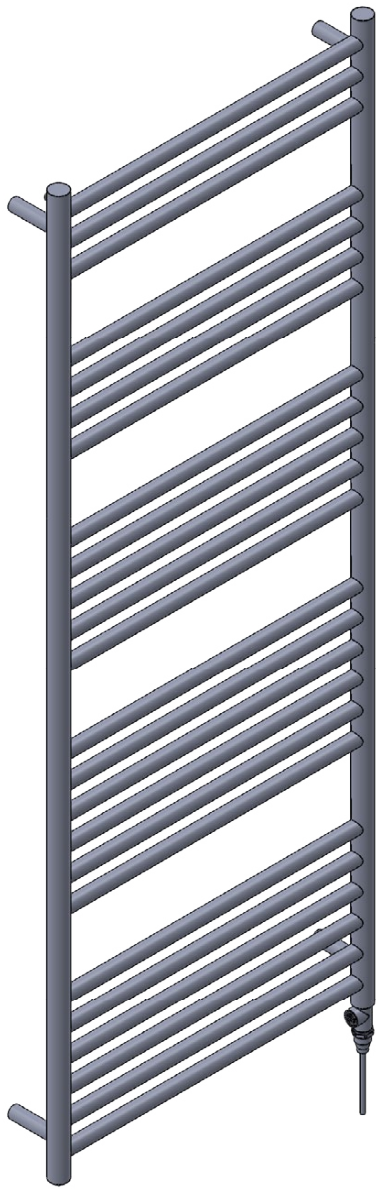

Narva Straight

All dimensions in millimetres

Manufactured from 1.4301/X5CrNi18-10 stainless steel

SCALE 1:10

E70217

Height: 800  
Width: 500  
Depth: 120

Tube  $\phi$ : 31.8 + 22  
Pipe Centres / Face-Face Cons: 468  
Output @ 50° C  $\Delta$  T Watts: 243 W  
BTUs: 829 W

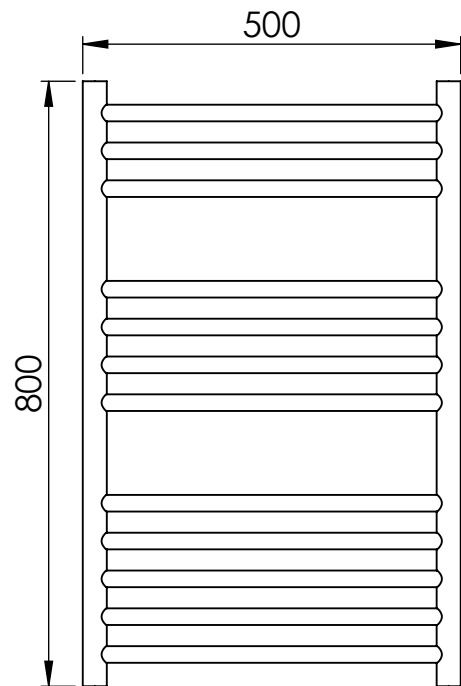
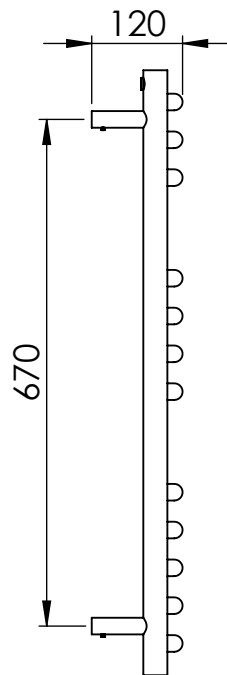
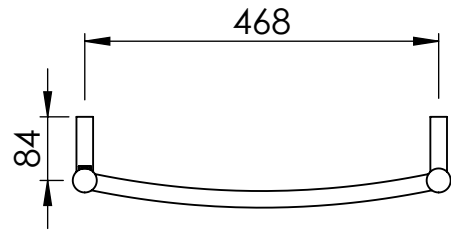
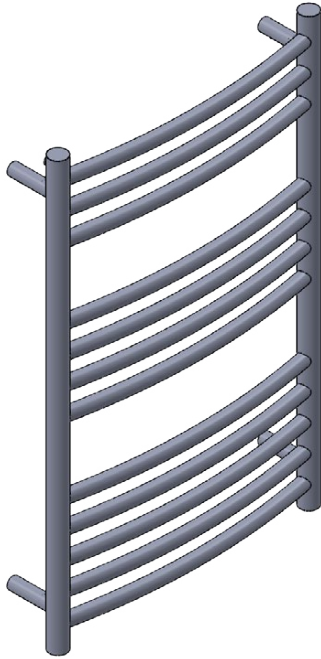

**esteem**<sup>®</sup>  
bathrooms

Narva Curved

All dimensions in millimetres

Manufactured from 1.4301/X5CrNi18-10 stainless steel

SCALE 1:8

E70218

Height: 800  
Width: 500  
Depth: 120

Tube  $\phi$  : 31.8 + 22  
Pipe Centres / Face-Face Cons: 468  
Elec. element if specified: 125 W

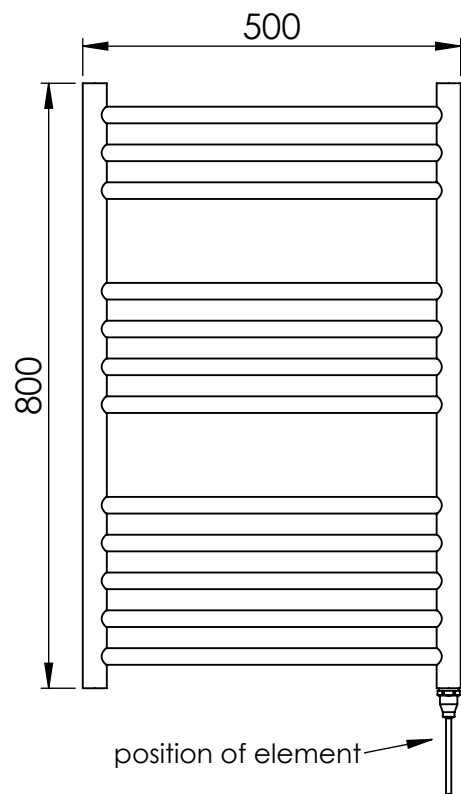
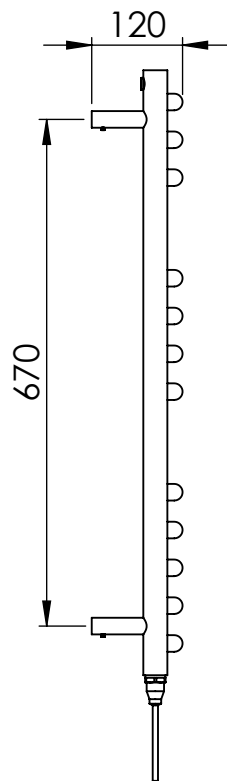
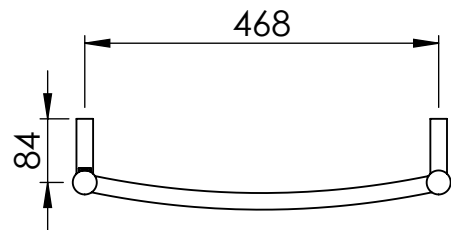
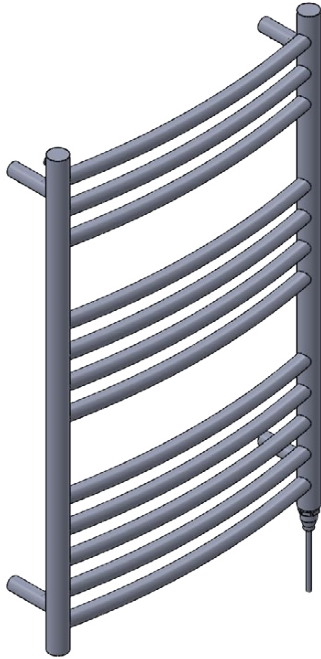

**esteem**<sup>®</sup>  
bathrooms

Narva Curved

All dimensions in millimetres

Manufactured from 1.4301/X5CrNi18-10 stainless steel

SCALE 1:8

E70219

Height: 800  
Width: 500  
Depth: 120

Tube  $\phi$  : 31.8 + 22  
Pipe Centres / Face-Face Cons: 468  
Elec. element if specified: 125 W  
Output @ 50° C  $\Delta$  T Watts: 243 W  
BTUs: 829 W

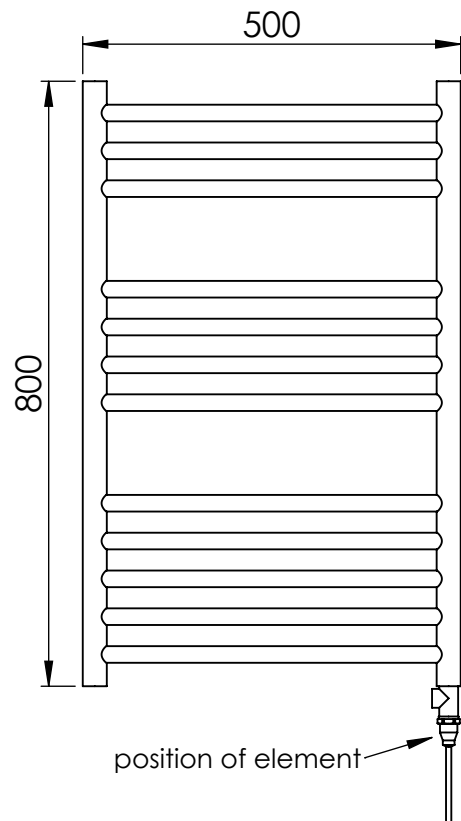
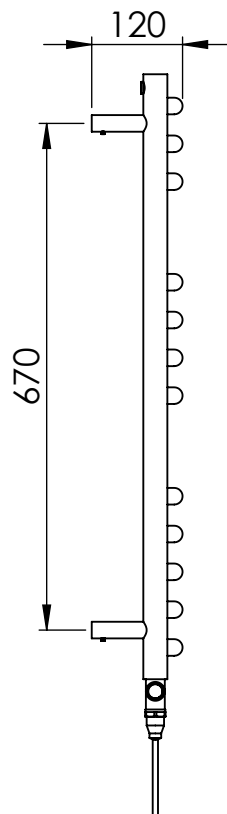
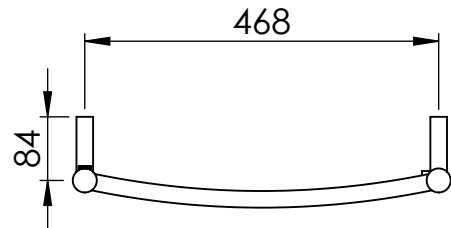
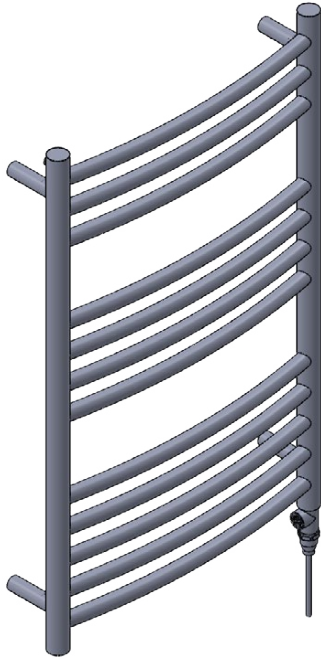

**esteem**<sup>®</sup>  
bathrooms

Narva Curved

All dimensions in millimetres

Manufactured from 1.4301/X5CrNi18-10 stainless steel

SCALE 1:8

E70220

Height: 800  
Width: 600  
Depth: 130

Tube  $\phi$  : 31.8 + 22  
Pipe Centres / Face-Face Cons: 568  
Output @ 50° C  $\Delta$  T Watts: 269 W  
BTUs: 918 W

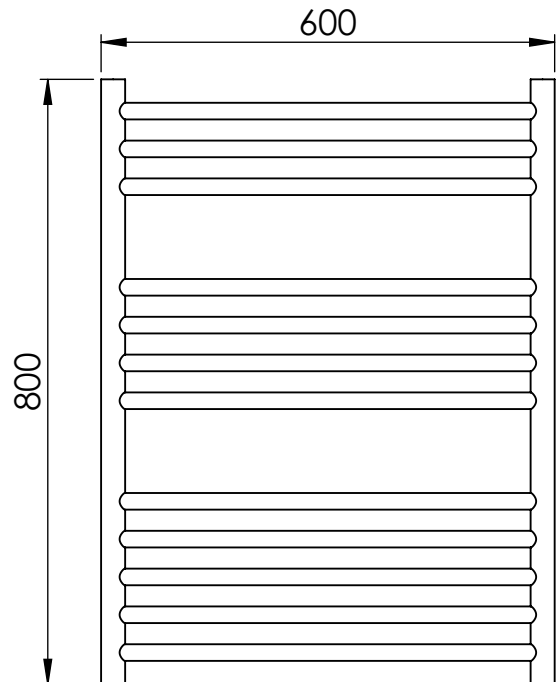
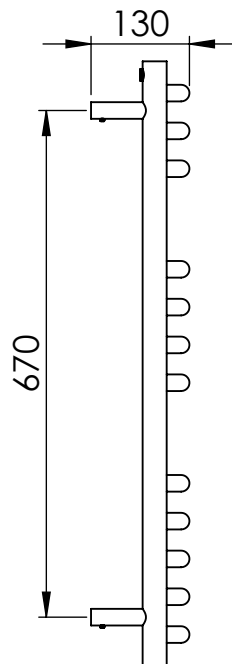
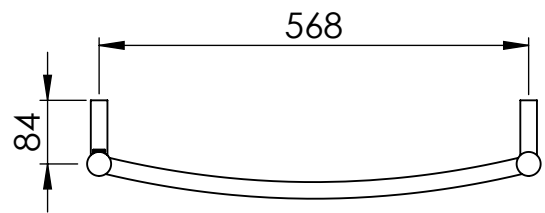
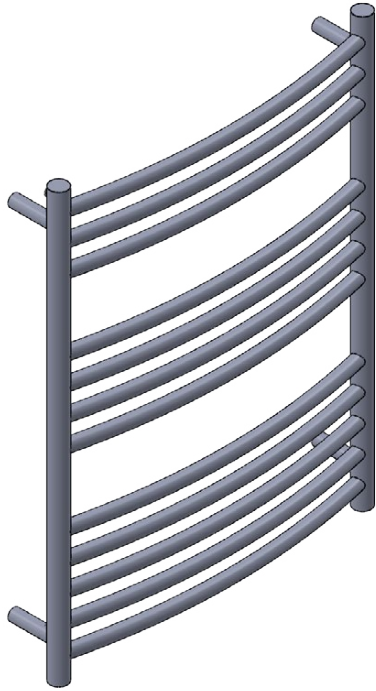

**esteem**<sup>®</sup>  
bathrooms

Narva Curved

All dimensions in millimetres

Manufactured from 1.4301/X5CrNi18-10 stainless steel

SCALE 1:8



E70221

Height: 800  
Width: 600  
Depth: 130

Tube  $\phi$  : 31.8 + 22  
Pipe Centres / Face-Face Cons: 568  
Elec. element if specified: 150 W

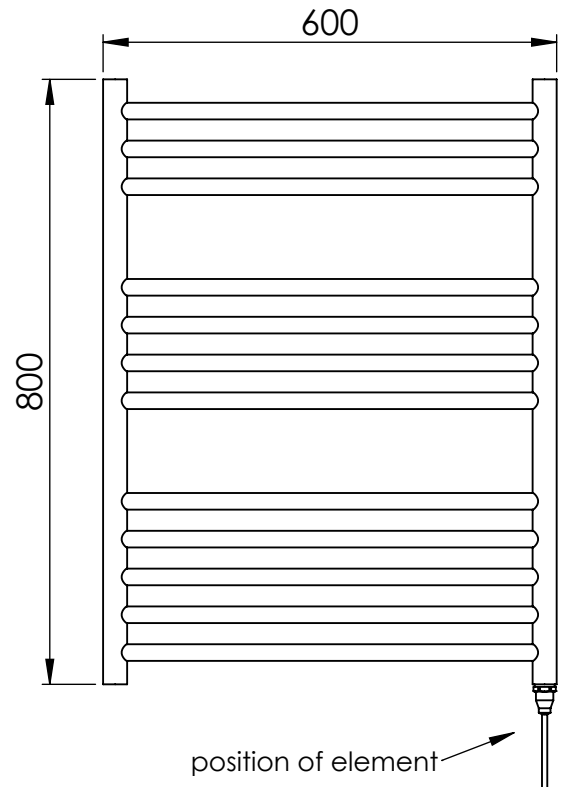
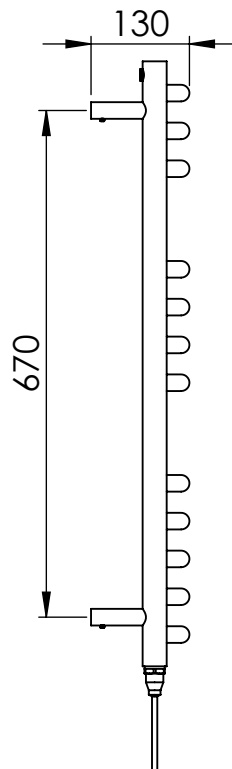
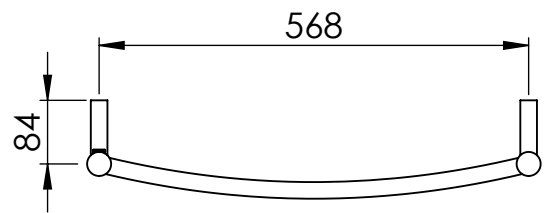
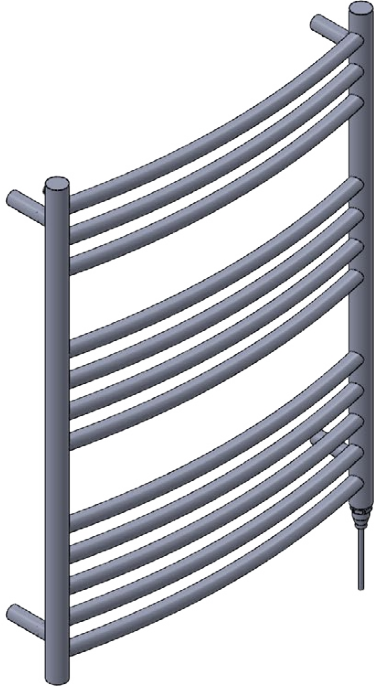

**esteem**<sup>®</sup>  
bathrooms

Narva Curved

All dimensions in millimetres

Manufactured from 1.4301/X5CrNi18-10 stainless steel

SCALE 1:8



E70222

Height: 800  
Width: 600  
Depth: 130

Tube  $\phi$  : 31.8 + 22  
Pipe Centres / Face-Face Cons: 568  
Elec. element if specified: 150 W  
Output @ 50° C  $\Delta$  T Watts: 269 W  
BTUs: 918 W

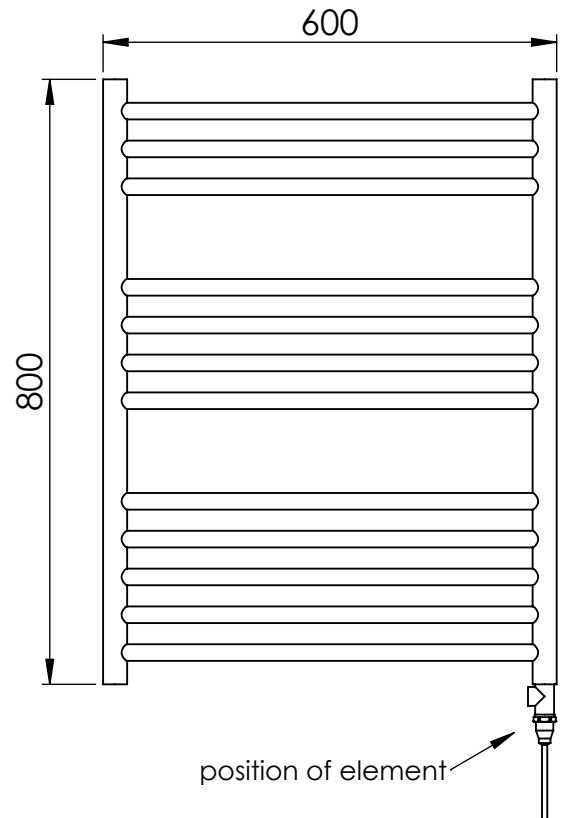
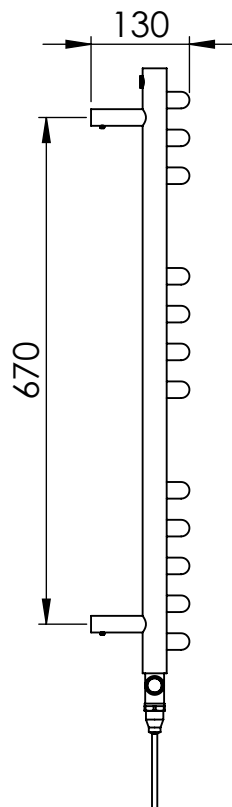
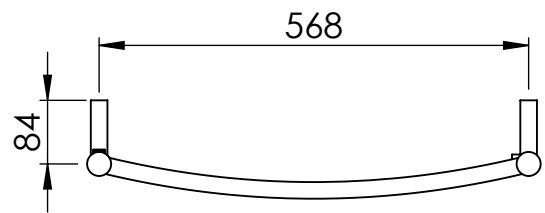
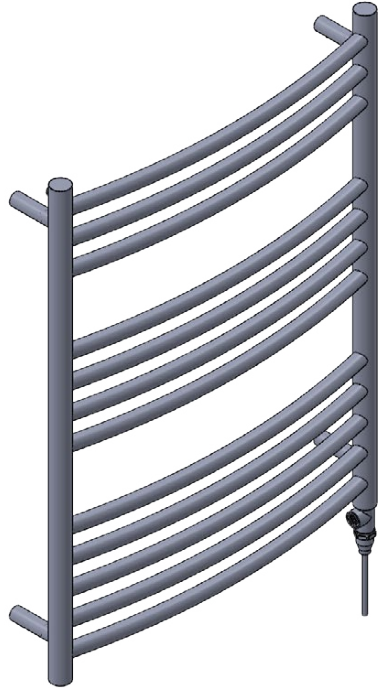

**esteem**<sup>®</sup>  
bathrooms

Narva Curved

All dimensions in millimetres

Manufactured from 1.4301/X5CrNi18-10 stainless steel

SCALE 1:8

E70223

Height: 1200  
Width: 500  
Depth: 120

Tube  $\phi$  : 31.8 + 22  
Pipe Centres / Face-Face Cons: 468  
Output @ 50° C  $\Delta$  T Watts: 348 W  
BTUs: 1187 W

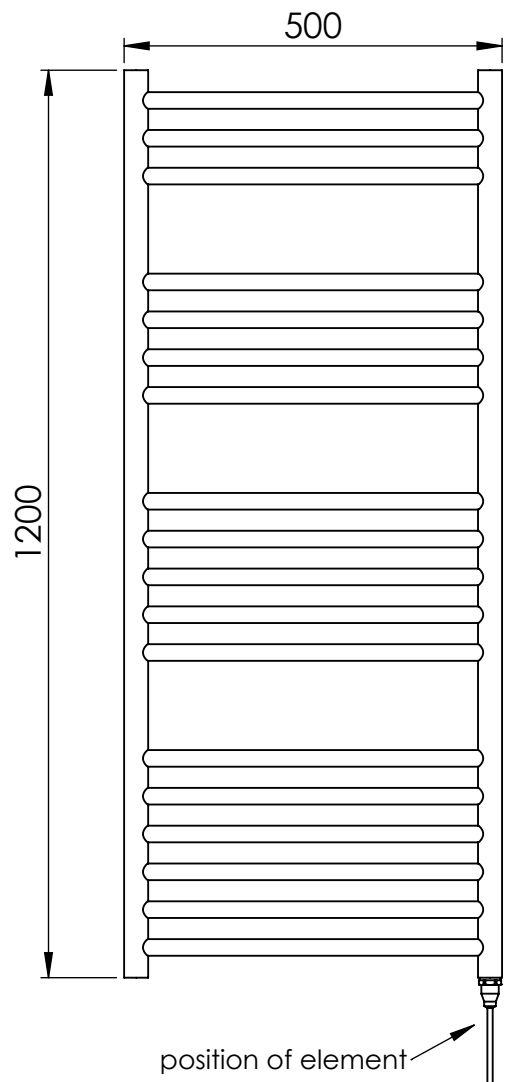
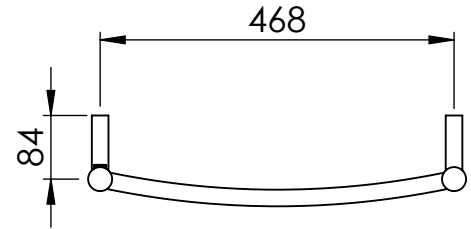
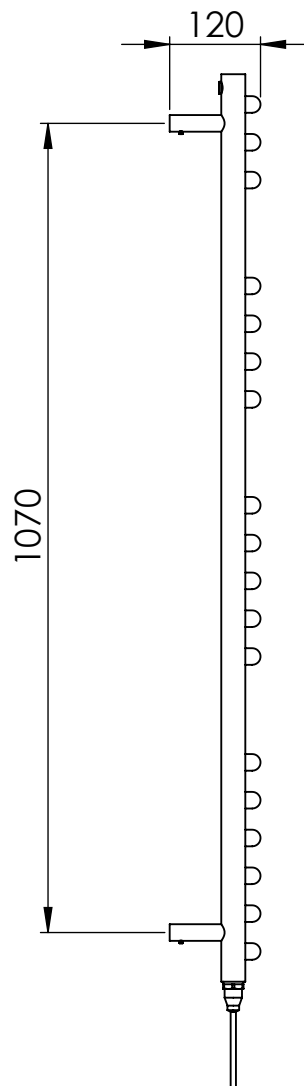
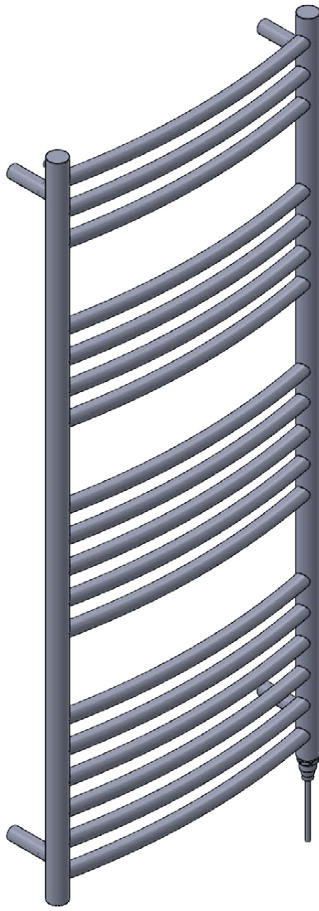

**esteem**<sup>®</sup>  
bathrooms

Narva Curved

All dimensions in millimetres

Manufactured from 1.4301/X5CrNi18-10 stainless steel

SCALE 1:8

E70224

Height: 1200  
Width: 500  
Depth: 120

Tube  $\phi$  : 31.8 + 22  
Pipe Centres / Face-Face Cons: 468  
Elec. element if specified: 200 W

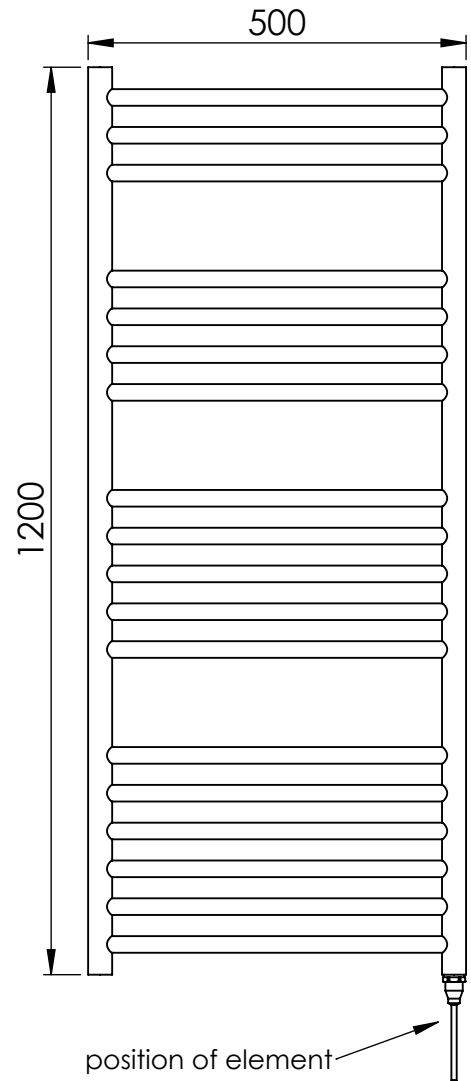
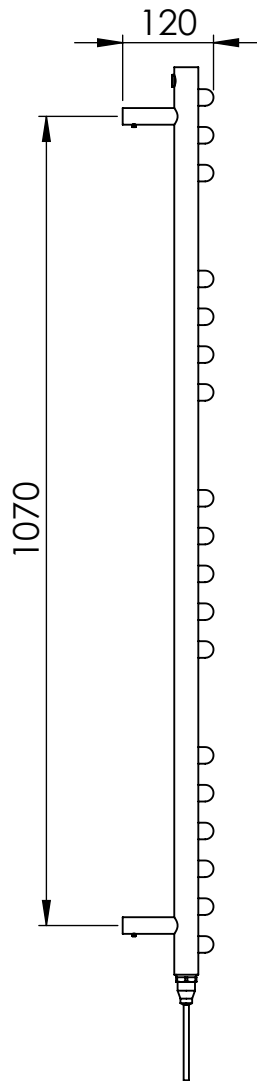
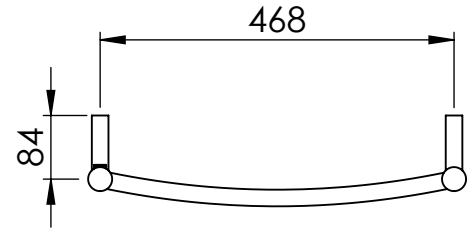
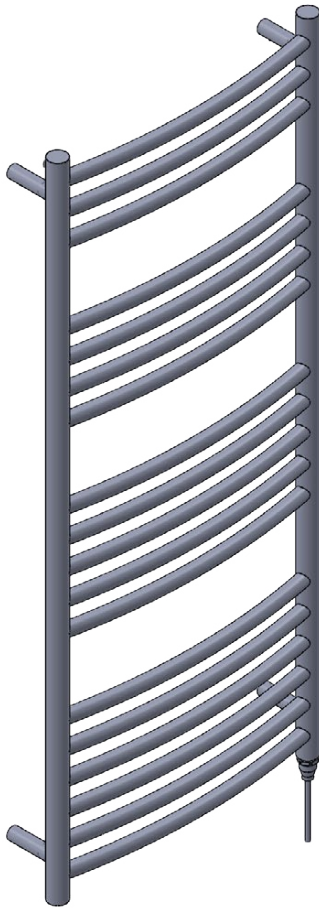

Narva Curved

All dimensions in millimetres

Manufactured from 1.4301/X5CrNi18-10 stainless steel

SCALE 1:8

E70225

Height: 1200  
Width: 500  
Depth: 120

Tube  $\phi$  : 31.8 + 22  
Pipe Centres / Face-Face Cons: 468  
Elec. element if specified: 200 W  
Output @ 50° C  $\Delta$  T Watts: 348 W  
BTUs: 1187 W

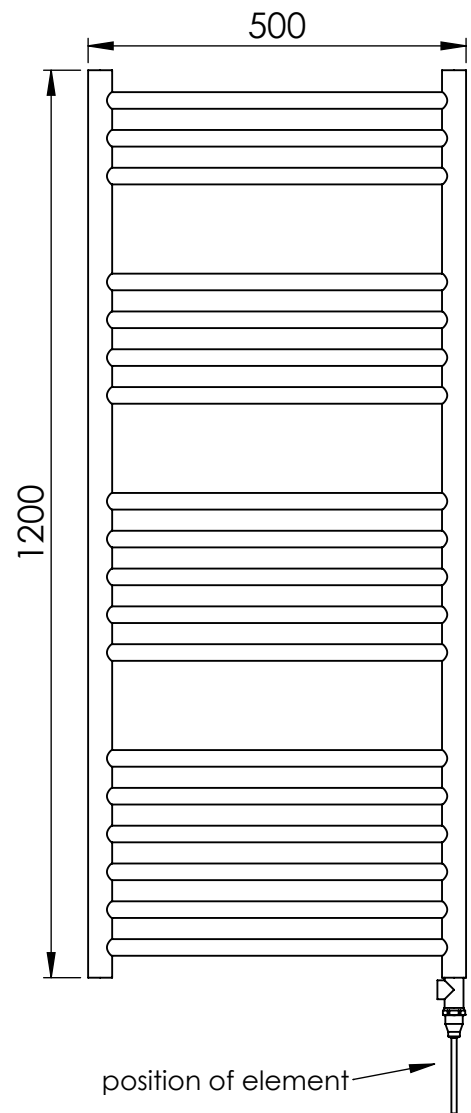
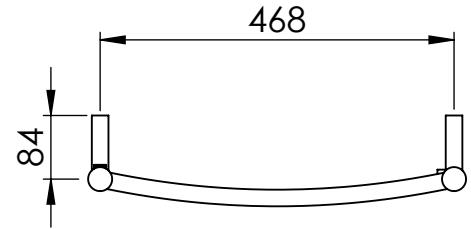
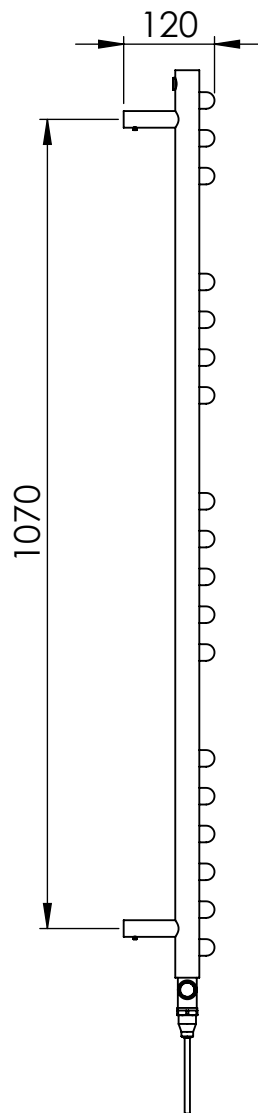
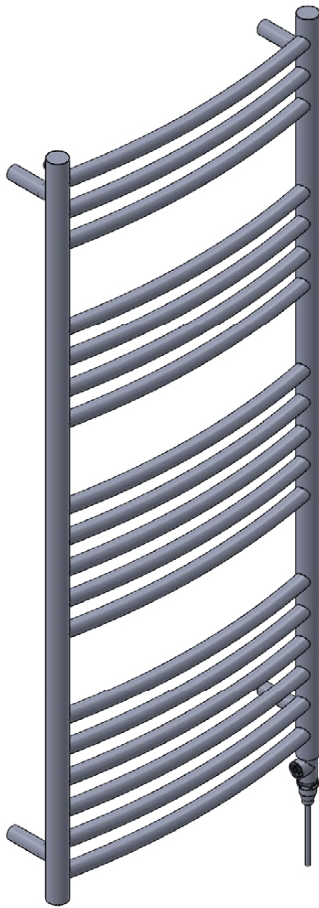

Narva Curved

All dimensions in millimetres

Manufactured from 1.4301/X5CrNi18-10 stainless steel

SCALE 1:8

E70226

Height: 1200  
Width: 600  
Depth: 130

Tube  $\phi$  : 31.8 + 22  
Pipe Centres / Face-Face Cons: 568  
Output @ 50° C  $\Delta$  T Watts: 402 W  
BTUs: 1372 W

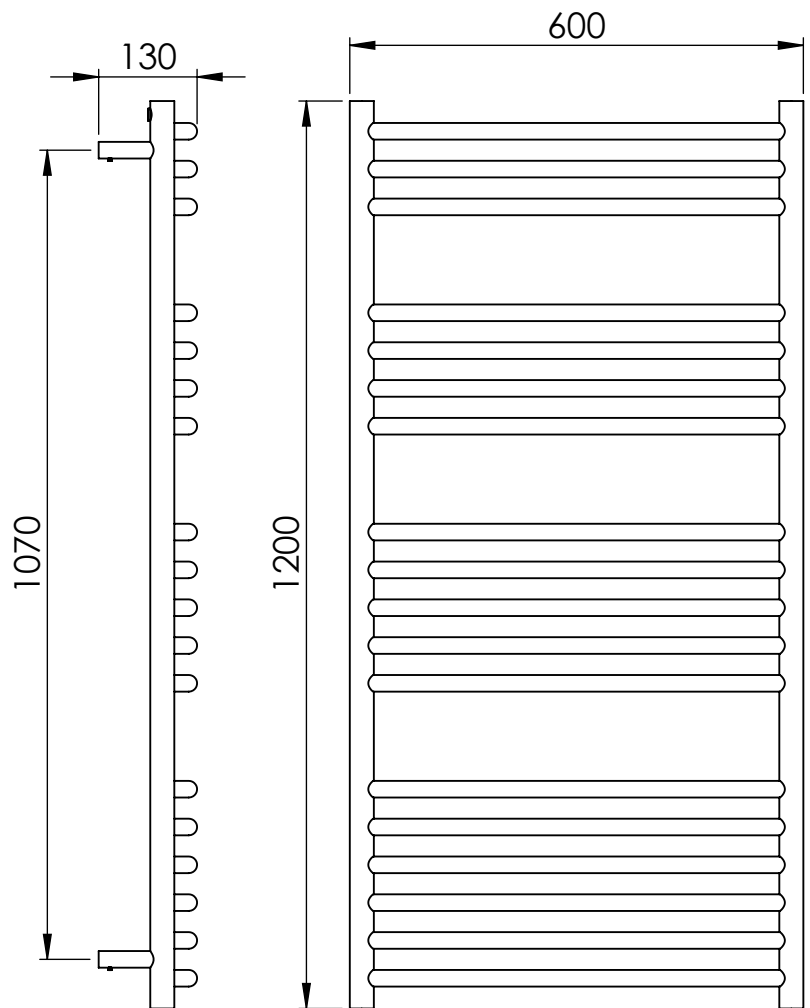
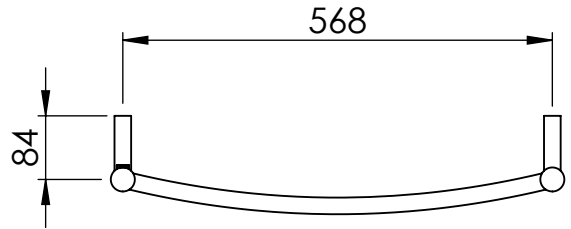
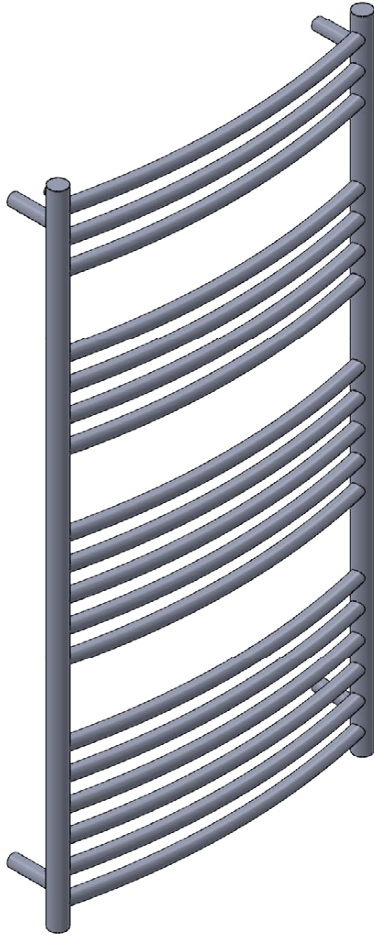

**esteem**<sup>®</sup>  
bathrooms

Narva Curved

All dimensions in millimetres

Manufactured from 1.4301/X5CrNi18-10 stainless steel

SCALE 1:8

E70227

Height: 1200  
Width: 600  
Depth: 130

Tube  $\phi$  : 31.8 + 22  
Pipe Centres / Face-Face Cons: 568  
Elec. element if specified: 200 W

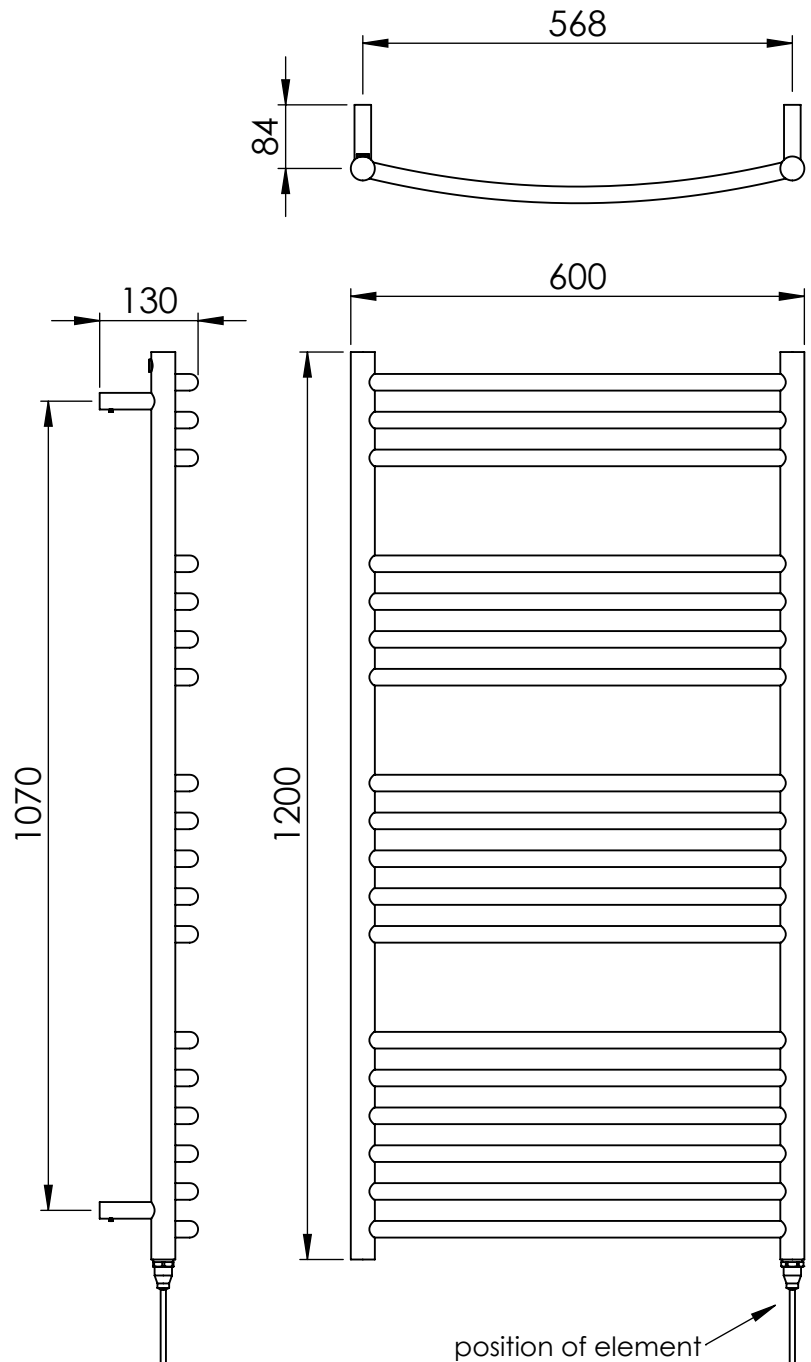
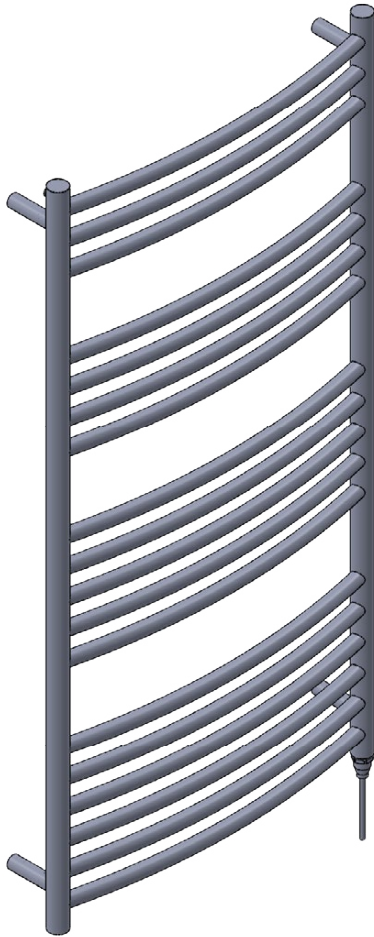

**esteem**<sup>®</sup>  
bathrooms

Narva Curved

All dimensions in millimetres

Manufactured from 1.4301/X5CrNi18-10 stainless steel

SCALE 1:8

E70228

Height: 1200  
Width: 600  
Depth: 130

Tube  $\phi$  : 31.8 + 22  
Pipe Centres / Face-Face Cons: 568  
Elec. element if specified: 200 W  
Output @ 50° C  $\Delta$  T Watts: 402 W  
BTUs: 1372 W

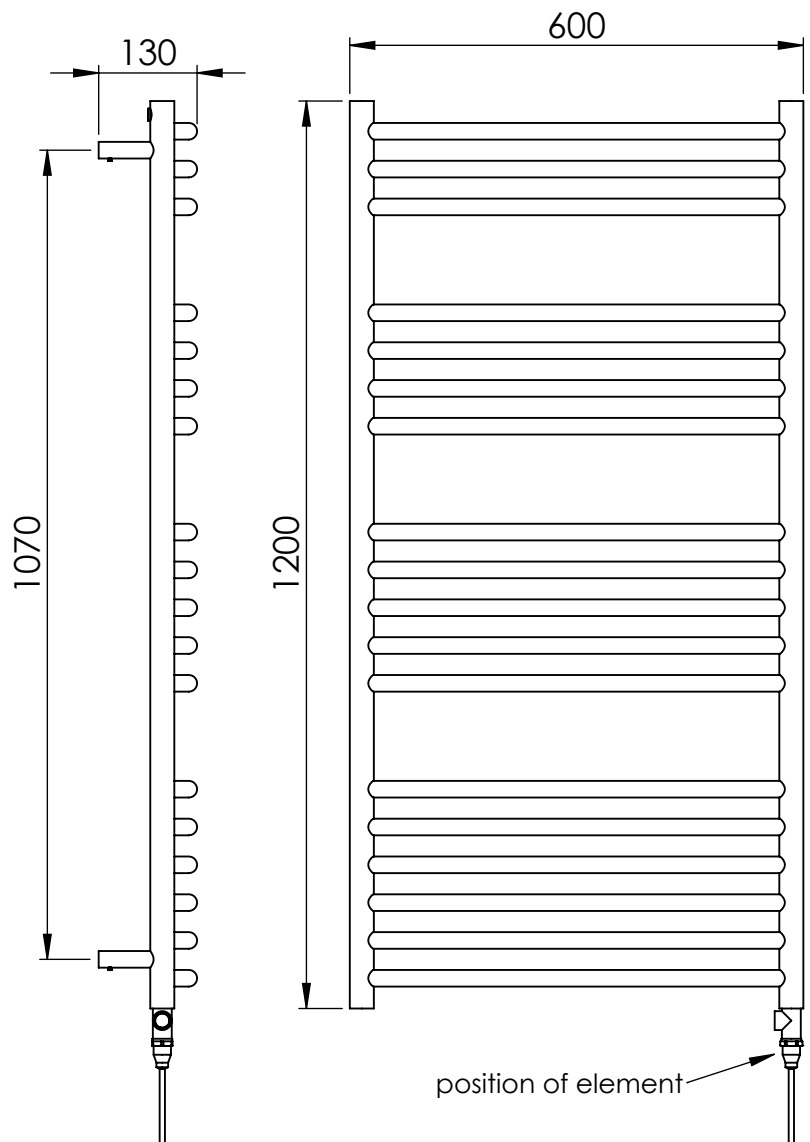
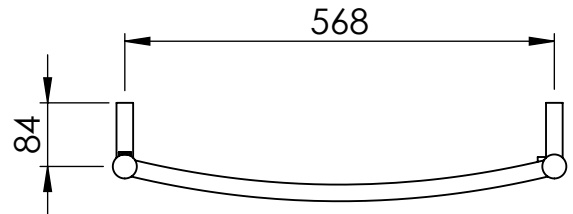
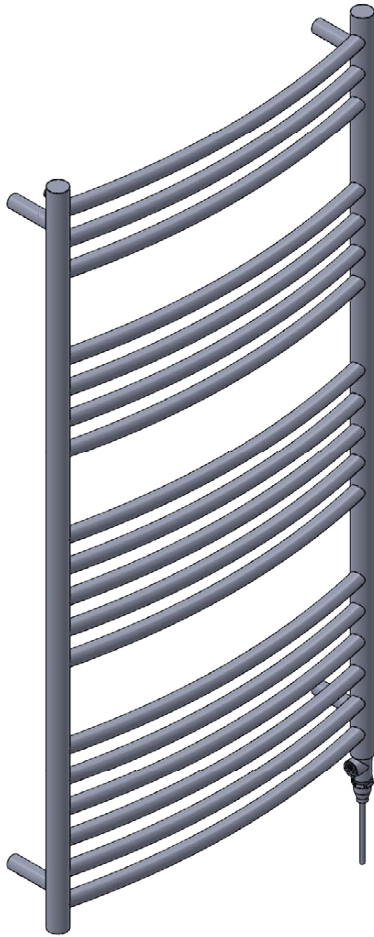

Narva Curved

All dimensions in millimetres

Manufactured from 1.4301/X5CrNi18-10 stainless steel

SCALE 1:8



E70229

Height: 1600  
Width: 500  
Depth: 120

Tube  $\phi$  : 31.8 + 22  
Pipe Centres / Face-Face Cons: 468  
Output @ 50° C  $\Delta$  T Watts: 464 W  
BTUs: 1583 W

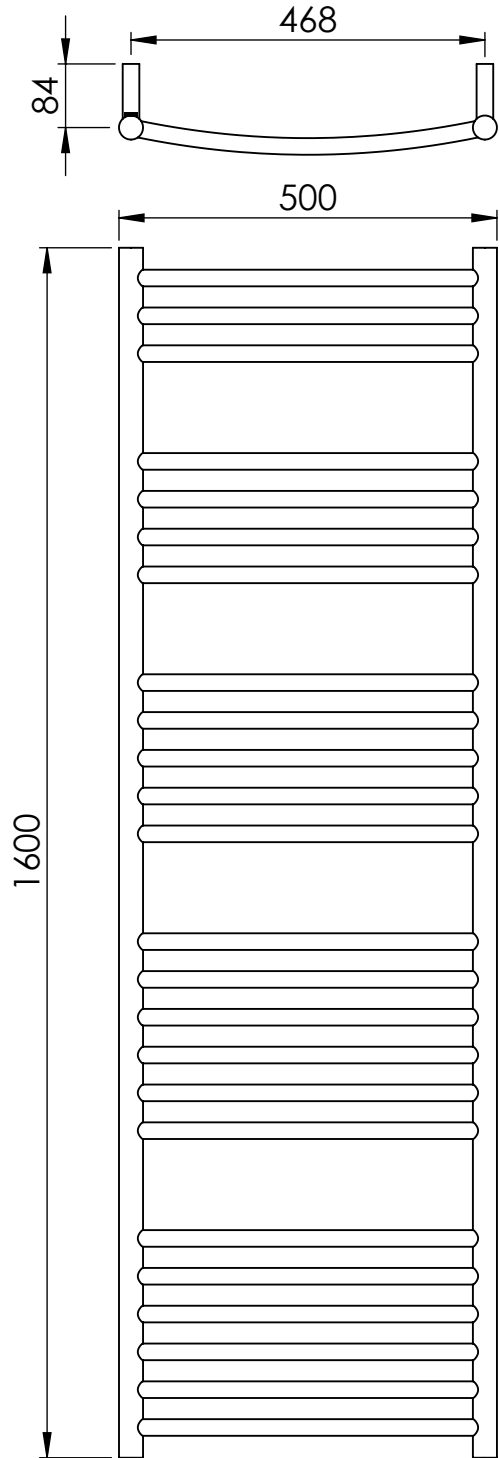
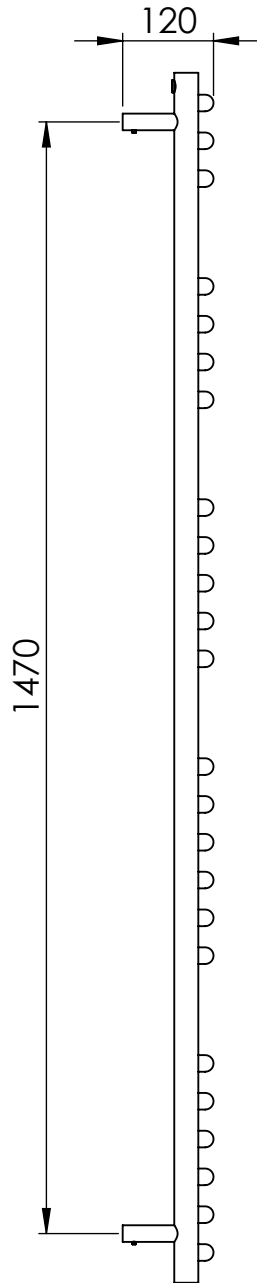
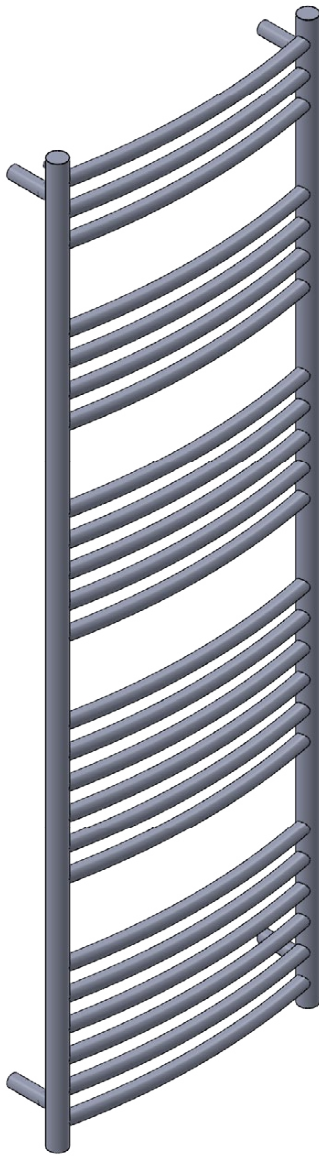

Narva Curved

All dimensions in millimetres

Manufactured from 1.4301/X5CrNi18-10 stainless steel

SCALE 1:8



E70230

Height: 1600  
Width: 500  
Depth: 120

Tube  $\phi$  : 31.8 + 22  
Pipe Centres / Face-Face Cons: 468  
Elec. element if specified: 300 W

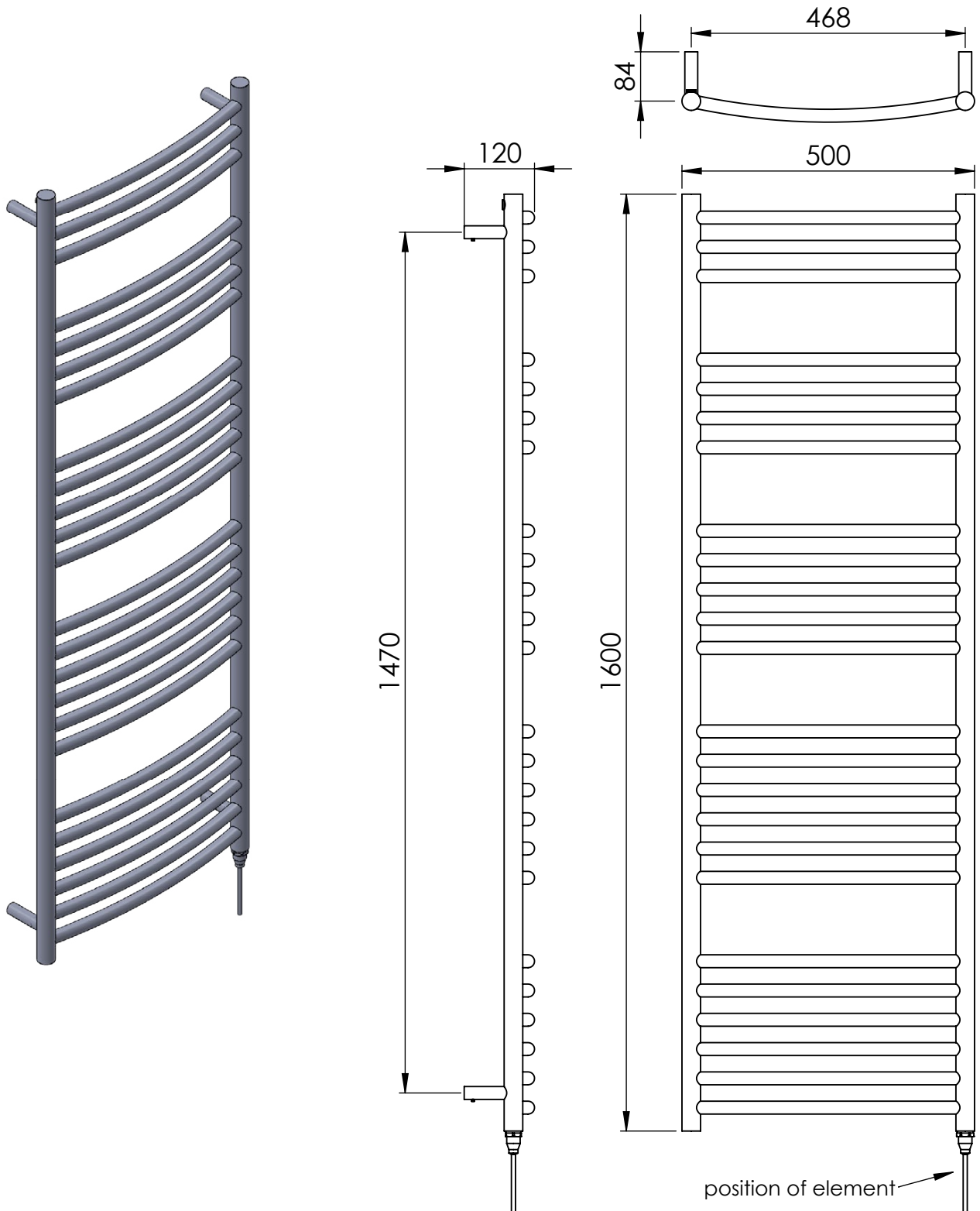

**esteem**<sup>®</sup>  
bathrooms

Narva Curved

All dimensions in millimetres

Manufactured from 1.4301/X5CrNi18-10 stainless steel

SCALE 1:8

# E70231

Height: 1600  
Width: 500  
Depth: 120

Tube  $\phi$  : 31.8 + 22  
Pipe Centres / Face-Face Cons: 468  
Elec. element if specified: 300 W  
Output @ 50° C  $\Delta$  T Watts: 464 W  
BTUs: 1583 W

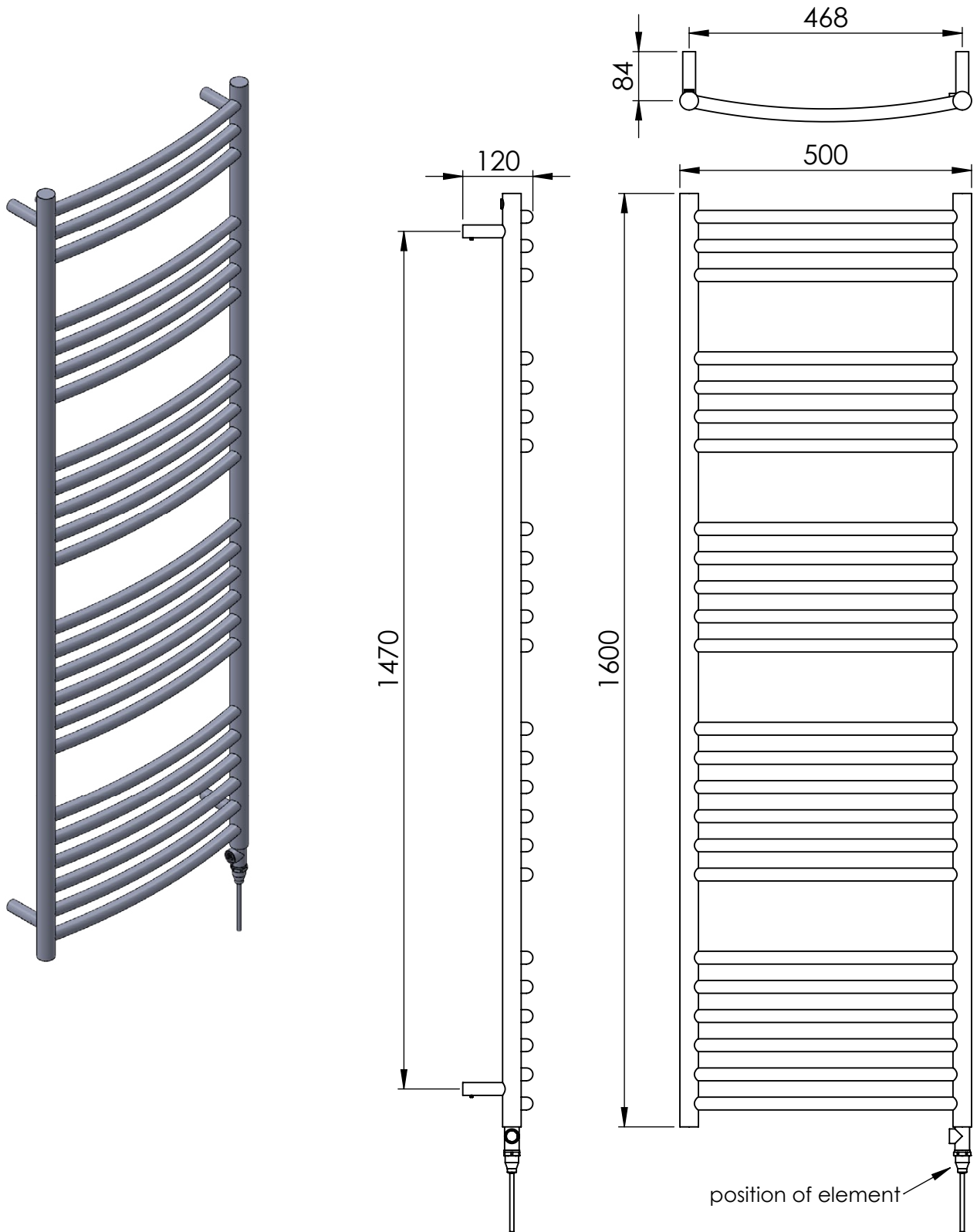

**esteem**<sup>®</sup>  
bathrooms

Narva Curved

All dimensions in millimetres

Manufactured from 1.4301/X5CrNi18-10 stainless steel

SCALE 1:8

E70232

Height: 1600  
Width: 600  
Depth: 130

Tube  $\phi$  : 31.8 + 22  
Pipe Centres / Face-Face Cons: 568  
Output @ 50° C  $\Delta$  T Watts: 536 W  
BTUs: 1829 W

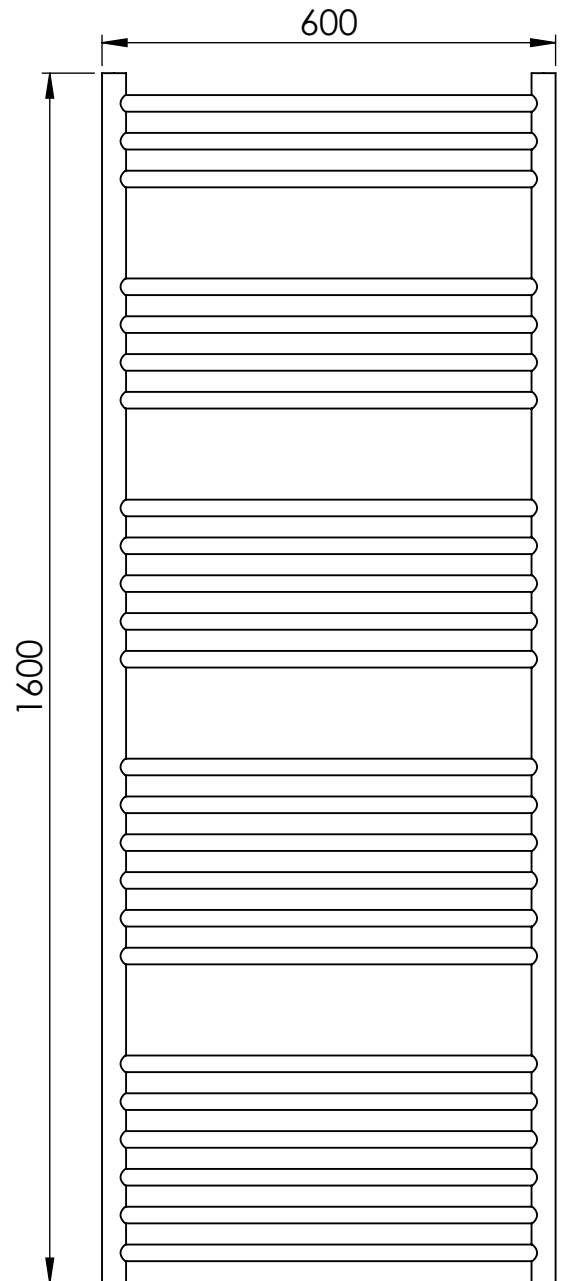
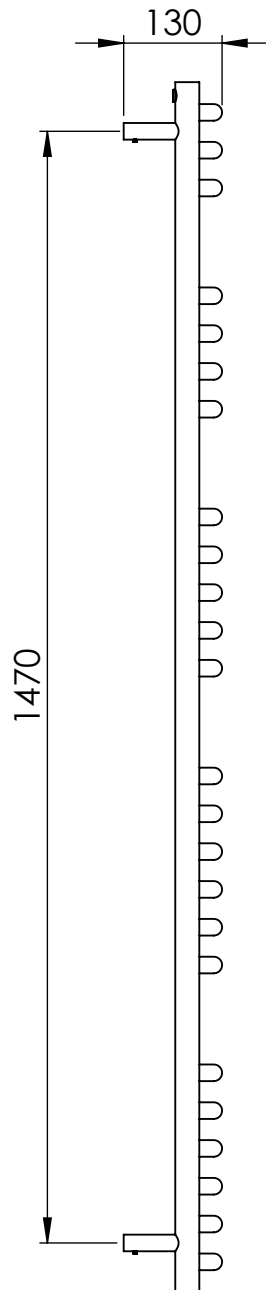
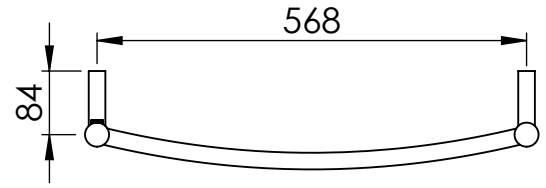
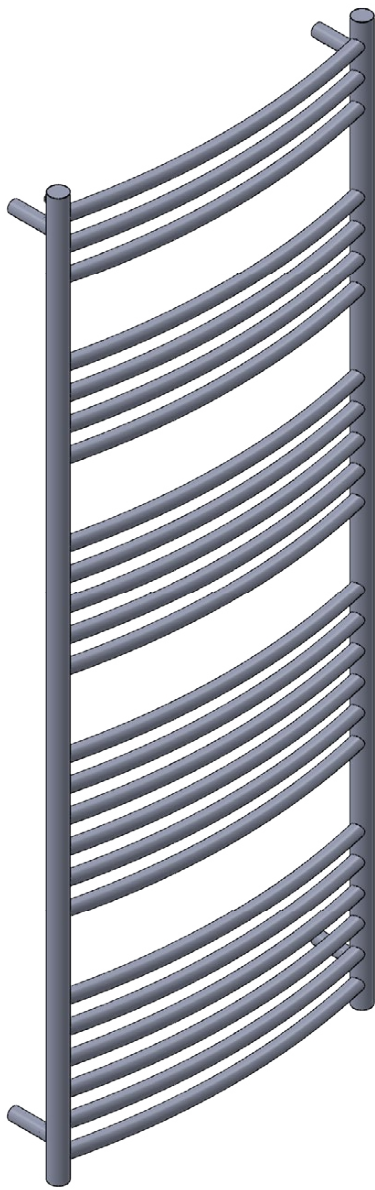

Narva Curved

All dimensions in millimetres

Manufactured from 1.4301/X5CrNi18-10 stainless steel

SCALE 1:8

E70233

Height: 1600  
Width: 600  
Depth: 130

Tube  $\phi$  : 31.8 + 22  
Pipe Centres / Face-Face Cons: 568  
Elec. element if specified: 300 W

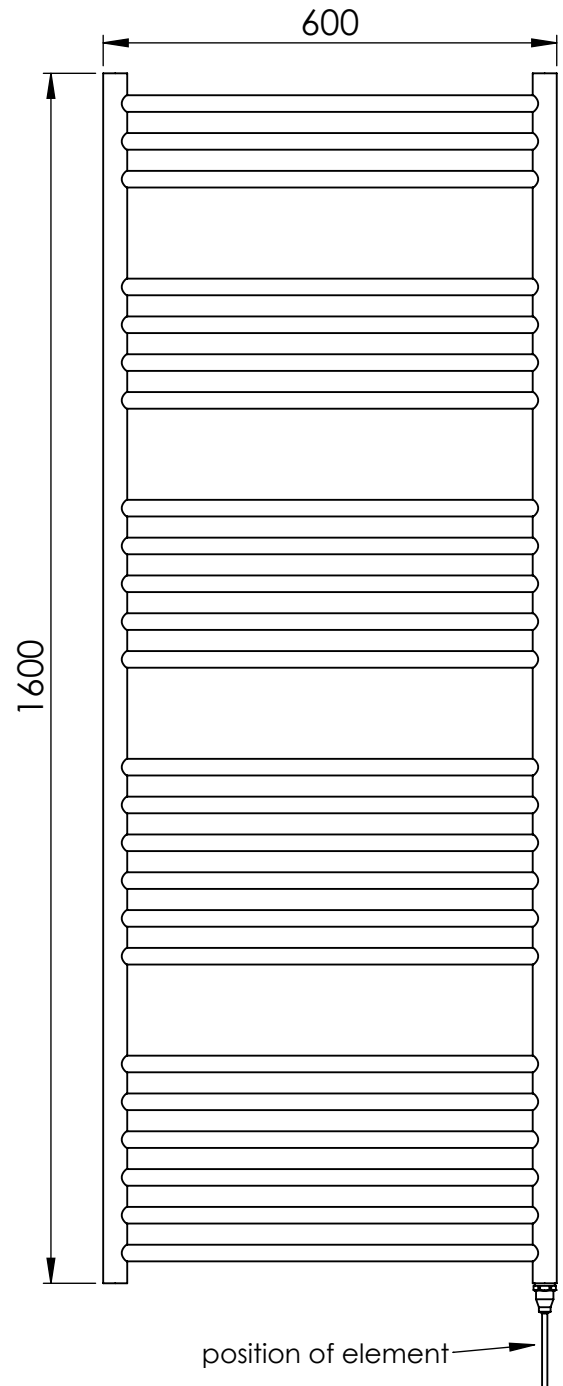
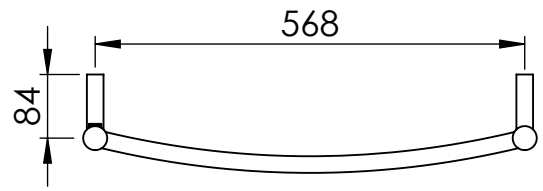
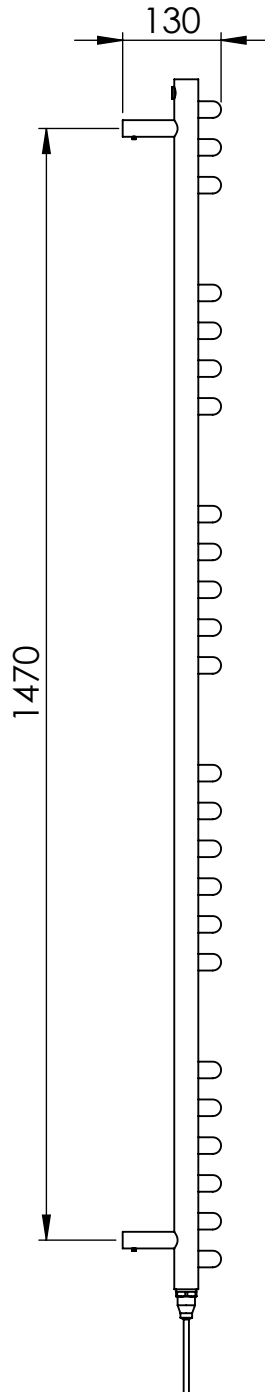
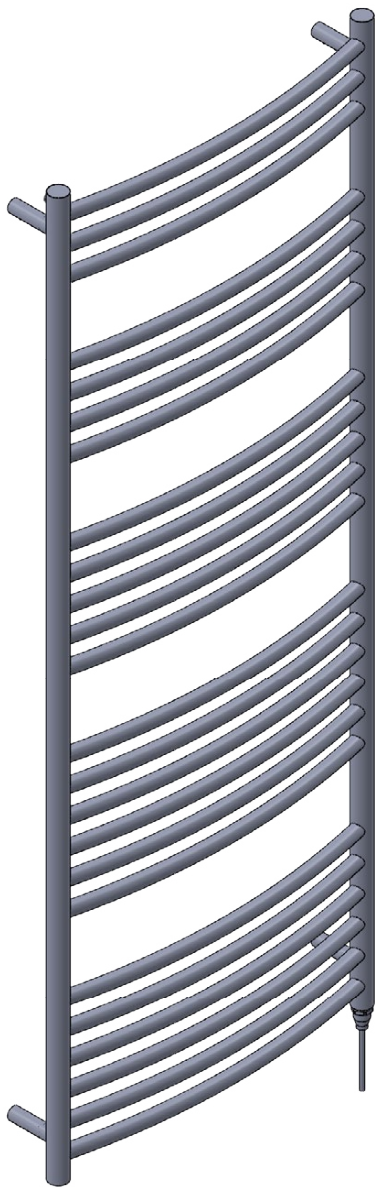

Narva Curved

All dimensions in millimetres

Manufactured from 1.4301/X5CrNi18-10 stainless steel

SCALE 1:8

E70234

Height: 1600  
Width: 600  
Depth: 130

Tube  $\phi$  : 31.8 + 22  
Pipe Centres / Face-Face Cons: 568  
Elec. element if specified: 300 W  
Output @ 50° C  $\Delta$  T Watts: 536 W  
BTUs: 1829 W

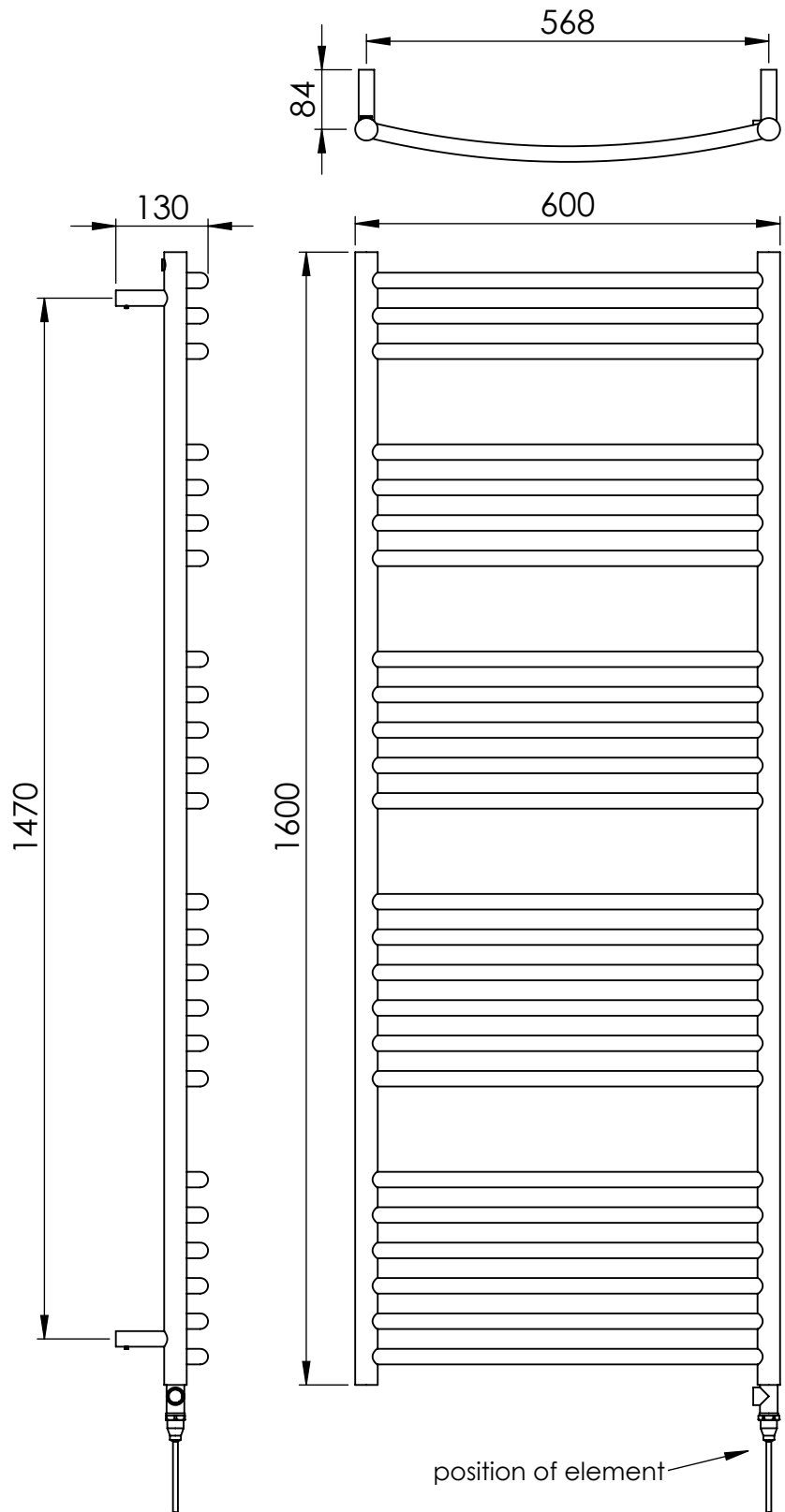
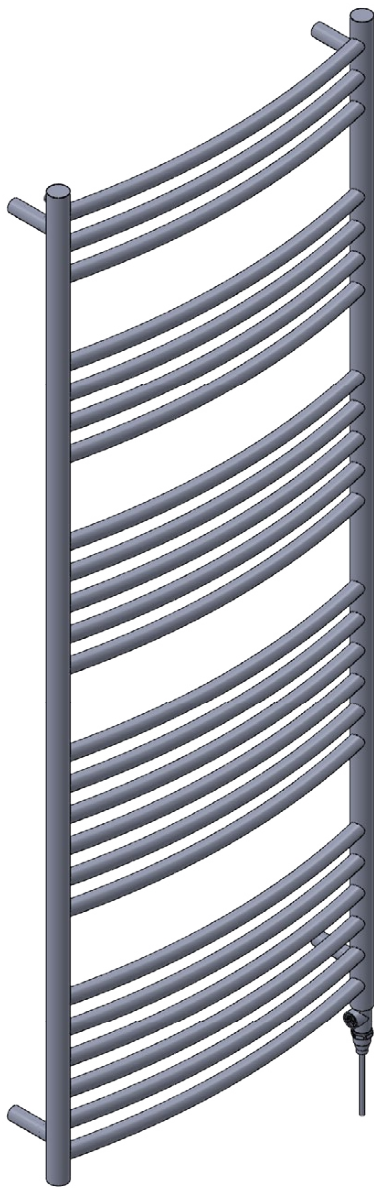

**esteem**<sup>®</sup>  
bathrooms

Narva Curved

All dimensions in millimetres

Manufactured from 1.4301/X5CrNi18-10 stainless steel

SCALE 1:8