

E70176

Height: 1200
Width: 252
Depth: 70

Tube ϕ : 30sq + 40x10sq
Pipe Centres / Face-Face Cons: 252
Elec. element if specified: n/a
Output @ 50° C Δ T Watts: 242 W
BTUs: 826 W

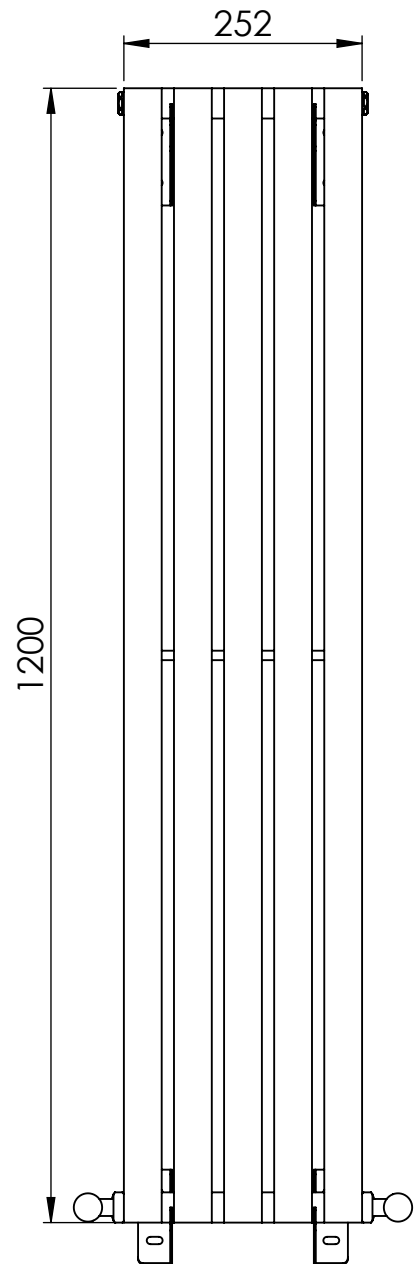
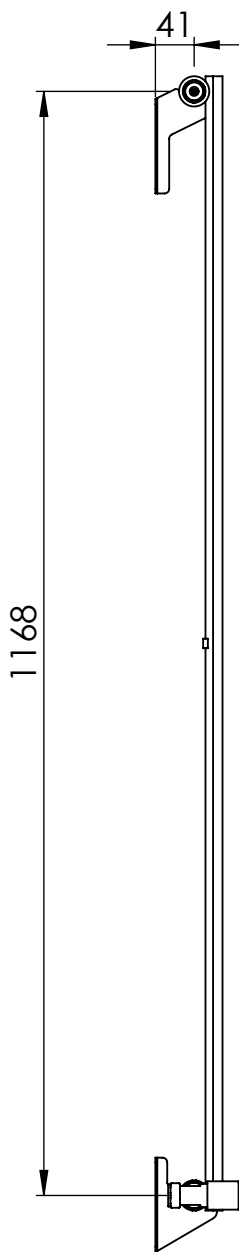
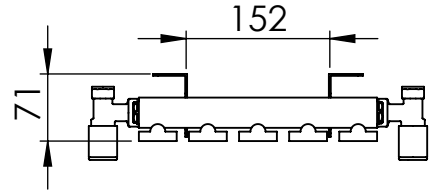
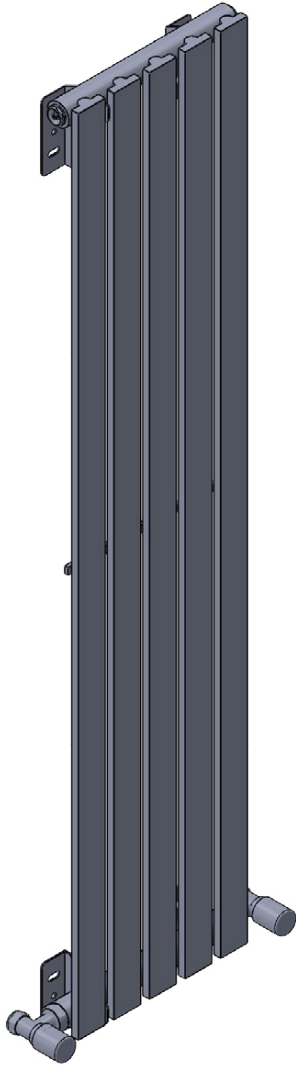

Bryde

All dimensions in millimetres

Manufactured from Mild Steel

SCALE 1:8

E70177

Height: 1200
Width: 252
Depth: 70

Tube ϕ : 30sq + 40x10sq
Pipe Centres / Face-Face Cons: 252
Elec. element if specified: n/a
Output @ 50°C Δ T Watts: 242 W
BTUs: 826 W

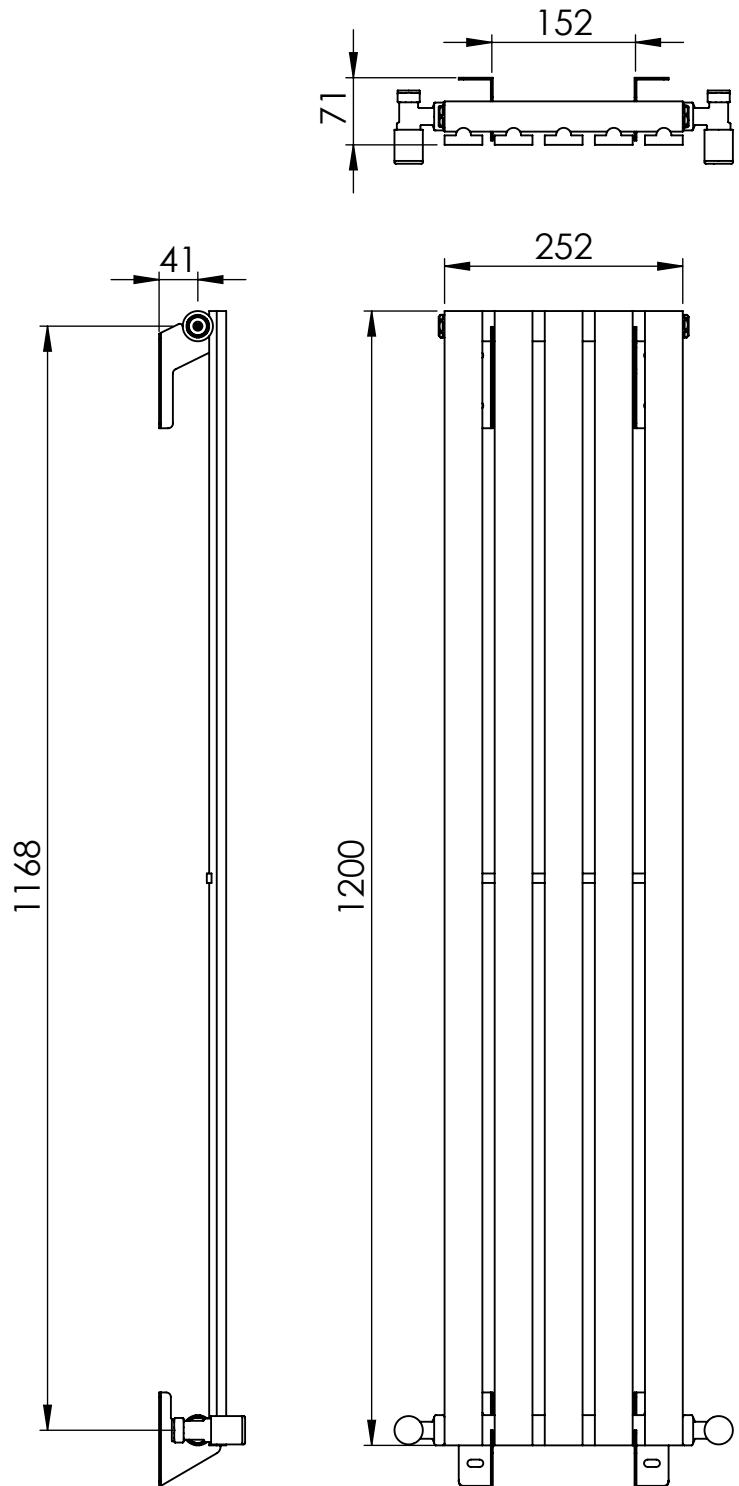
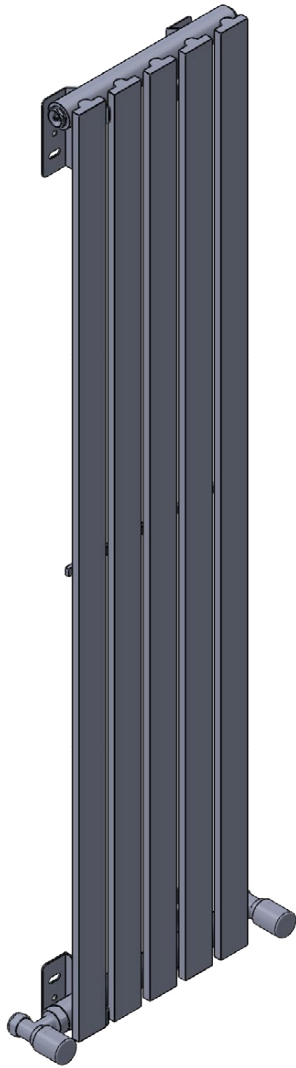

esteem[®]
bathrooms

Bryde

All dimensions in millimetres

Manufactured from Mild Steel

SCALE 1:8

E70178

Height: 1200
Width: 252
Depth: 70

Tube ϕ : 30sq + 40x10sq
Pipe Centres / Face-Face Cons: 252
Elec. element if specified: n/a
Output @ 50° C Δ T Watts: 242 W
BTUs: 826 W

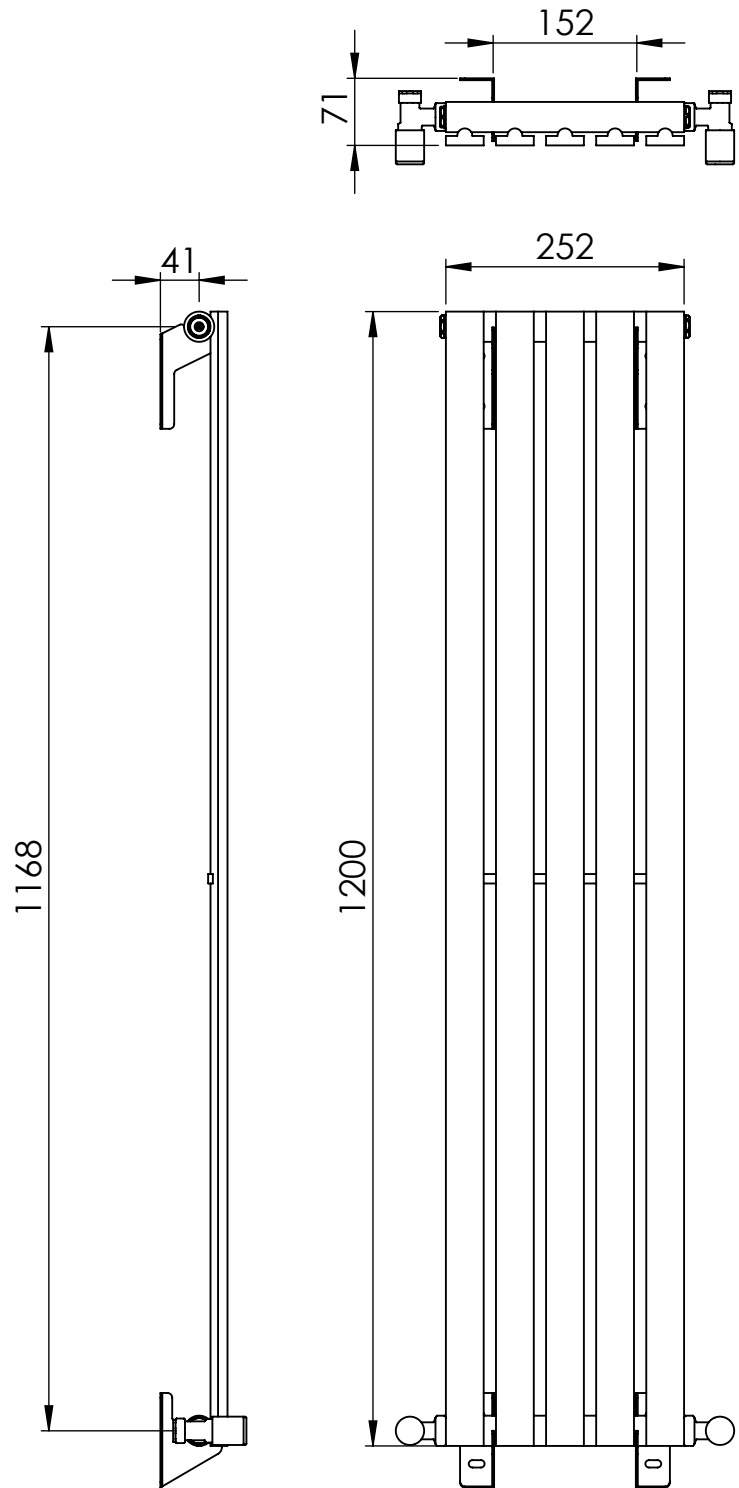
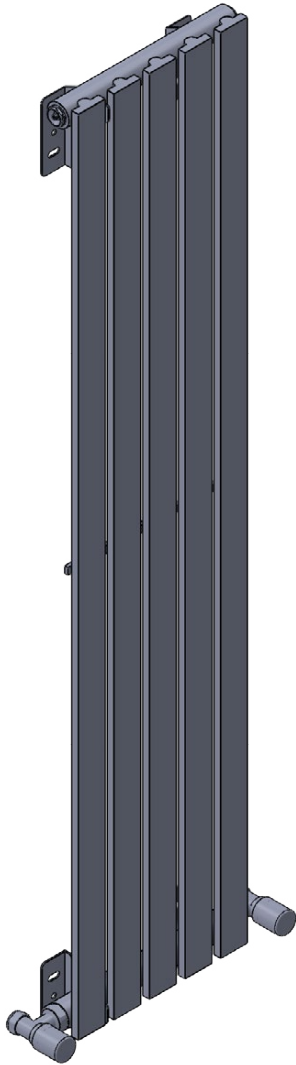

Bryde

All dimensions in millimetres

Manufactured from Mild Steel

SCALE 1:8

E70179

Height: 1200
Width: 358
Depth: 70

Tube Φ : 30sq + 40x10sq
Pipe Centres / Face-Face Cons: 358
Elec. element if specified: n/a
Output @ 50° C Δ T Watts: 339 W
BTUs: 1157 W

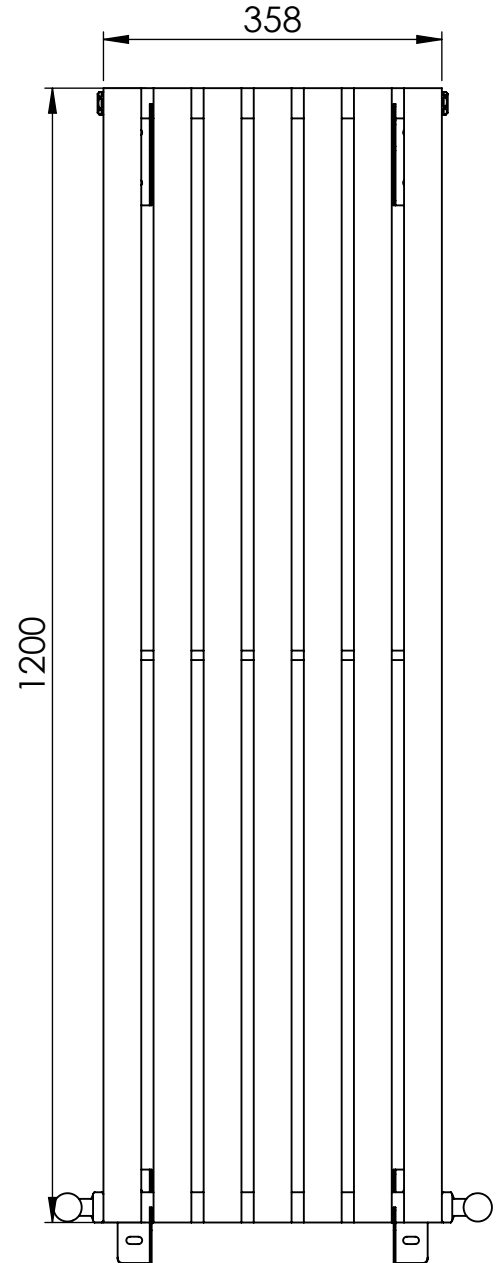
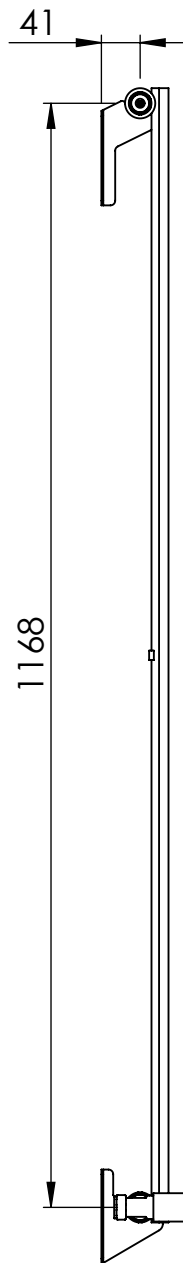
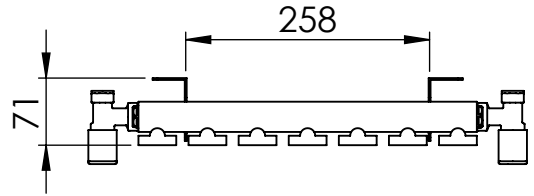
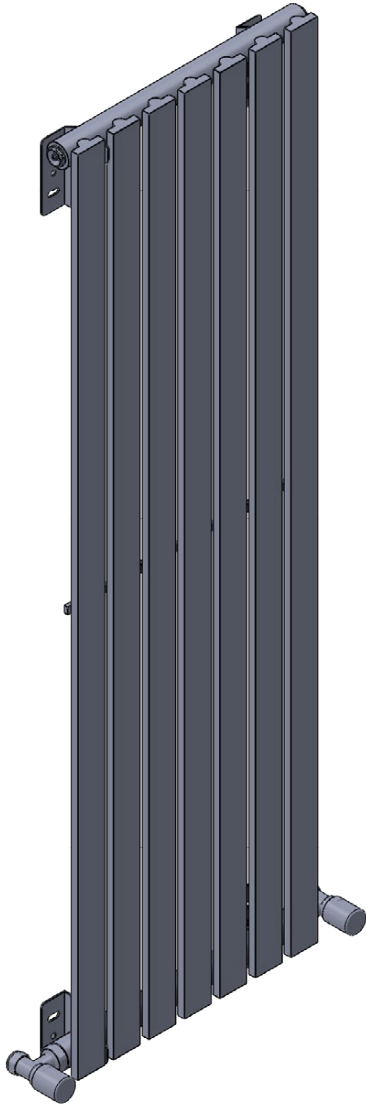

Bryde

All dimensions in millimetres

Manufactured from Mild Steel

SCALE 1:8

E70180

Height: 1200
Width: 358
Depth: 70

Tube Φ : 30sq + 40x10sq
Pipe Centres / Face-Face Cons: 358
Elec. element if specified: n/a
Output @ 50° C Δ T Watts: 339 W
BTUs: 1157 W

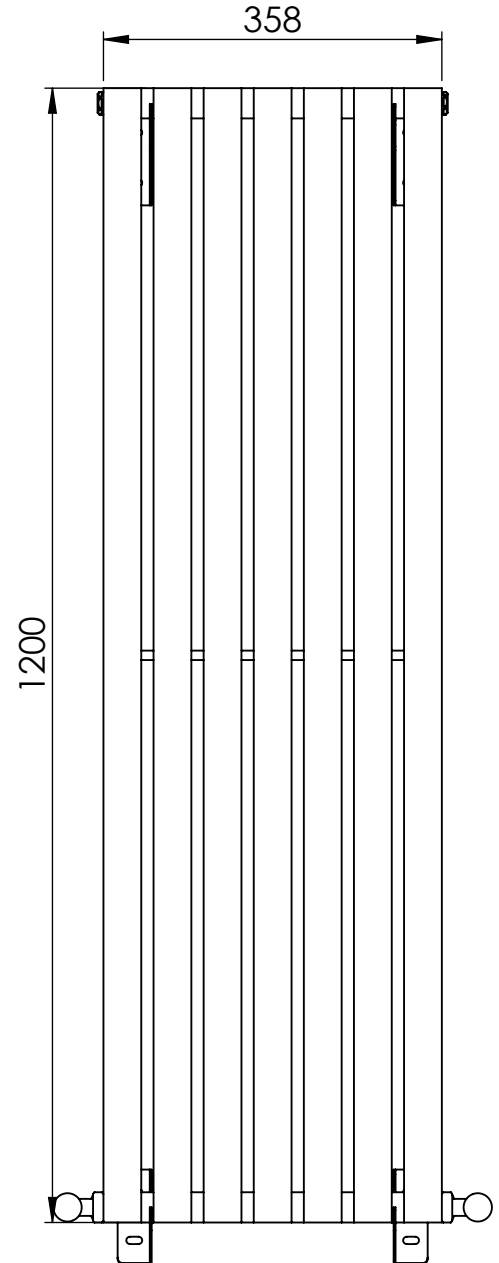
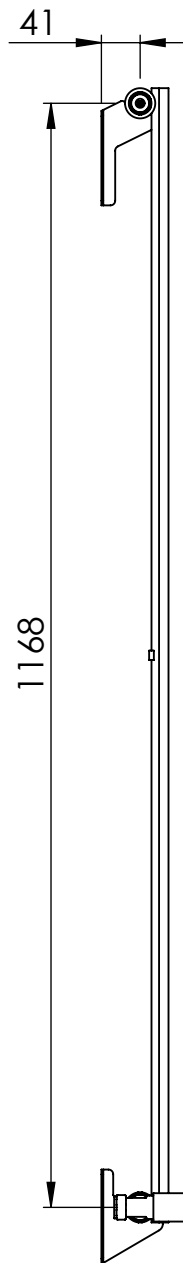
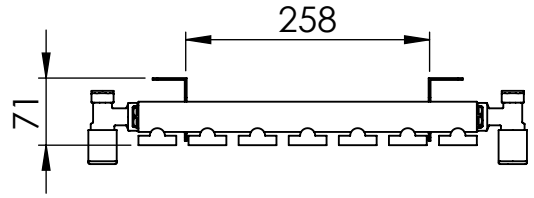
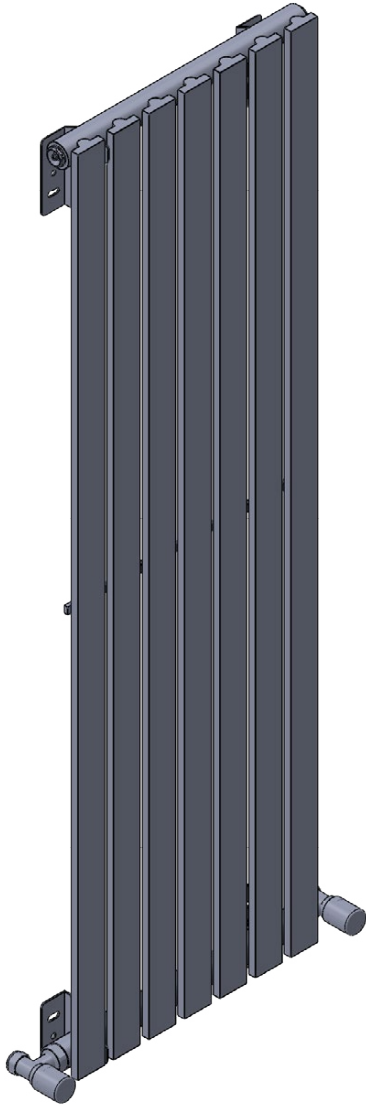

Bryde

All dimensions in millimetres

Manufactured from Mild Steel

SCALE 1:8

E70181

Height: 1200
Width: 358
Depth: 70

Tube Φ : 30sq + 40x10sq
Pipe Centres / Face-Face Cons: 358
Elec. element if specified: n/a
Output @ 50° C Δ T Watts: 339 W
BTUs: 1157 W

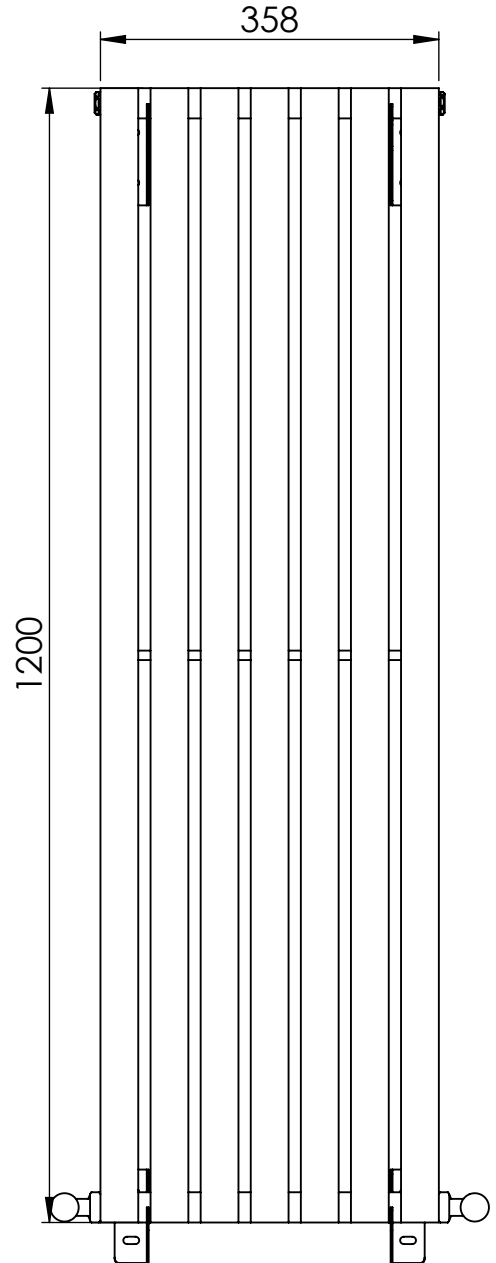
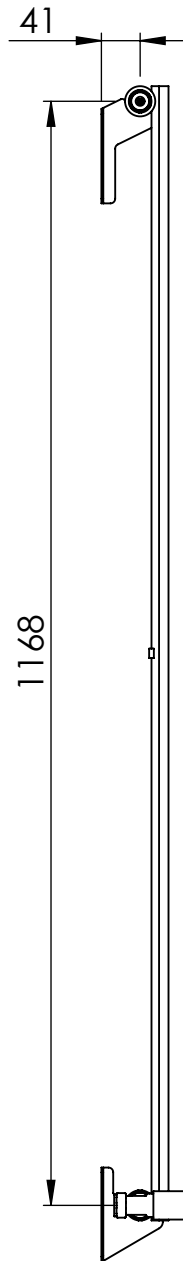
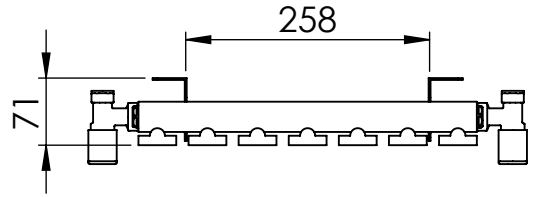
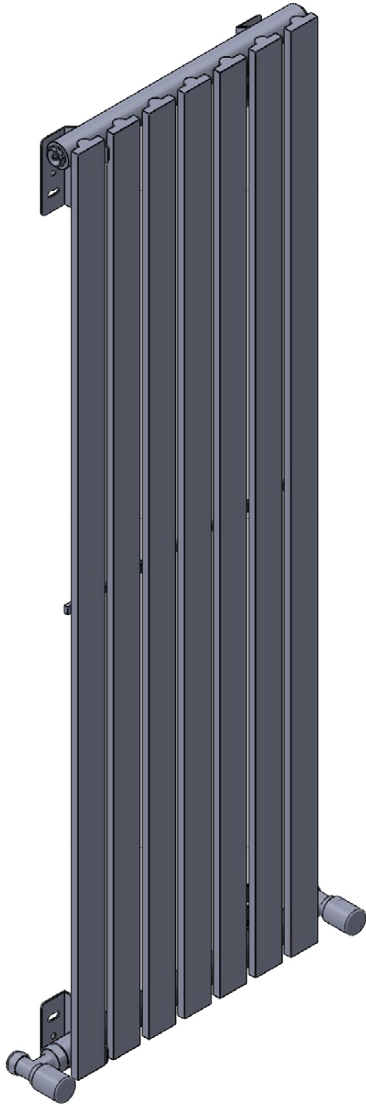

Bryde

All dimensions in millimetres

Manufactured from Mild Steel

SCALE 1:8

E70182

Height: 1800
Width: 252
Depth: 70

Tube Φ : 30sq + 40x10sq
Pipe Centres / Face-Face Cons: 252
Elec. element if specified: n/a
Output @ 50° C Δ T Watts: 351 W
BTUs: 1198 W

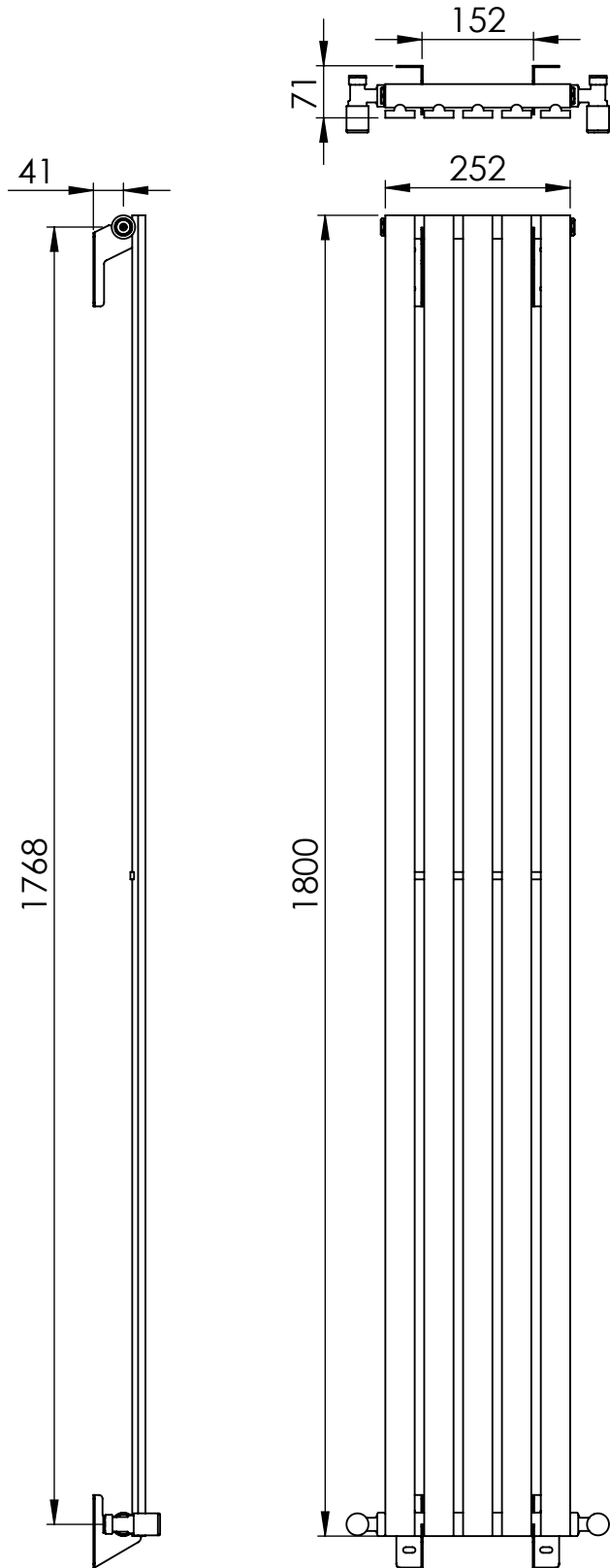
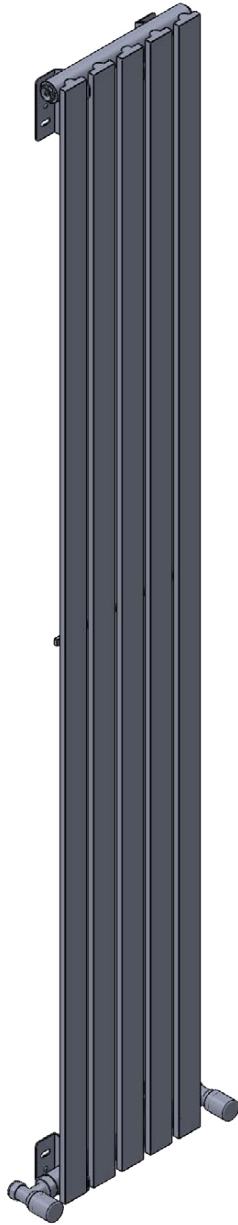

esteem[®]
bathrooms

Bryde

All dimensions in millimetres

Manufactured from Mild Steel

SCALE 1:10

E70183

Height: 1800
Width: 252
Depth: 70

Tube Φ : 30sq + 40x10sq
Pipe Centres / Face-Face Cons: 252
Elec. element if specified: n/a
Output @ 50° C Δ T Watts: 351 W
BTUs: 1198 W

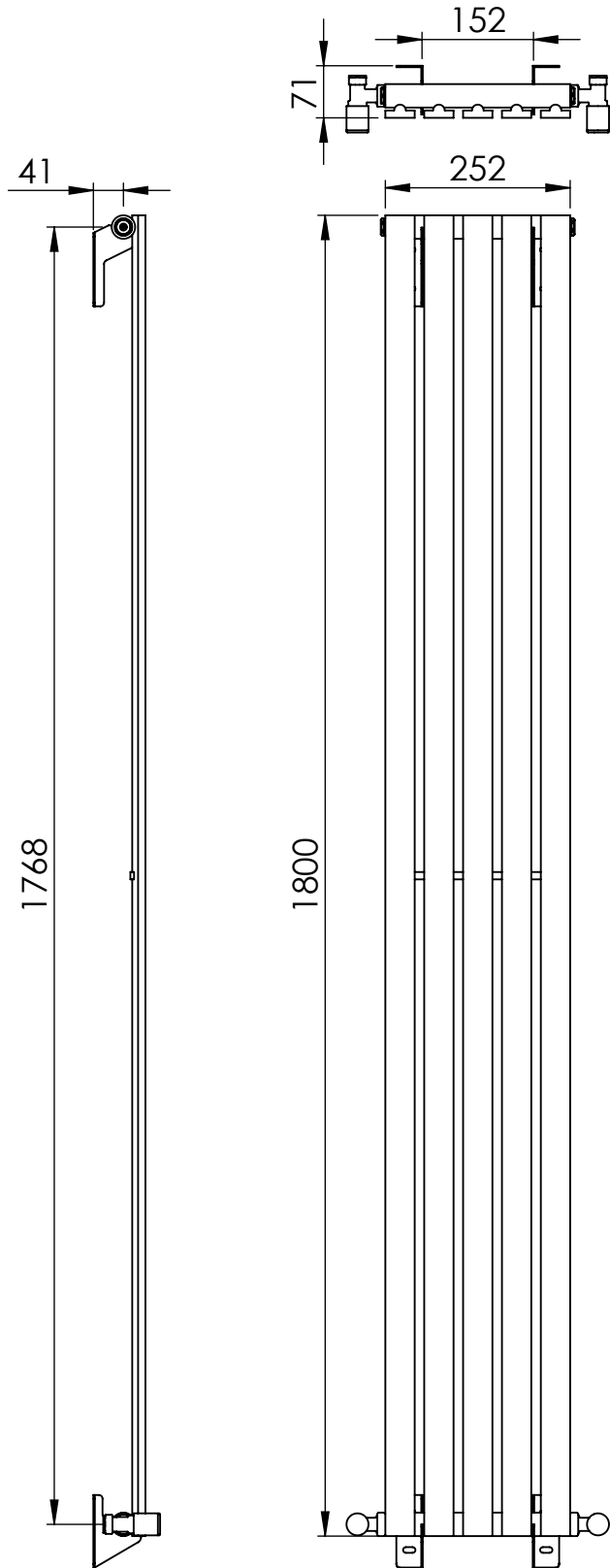
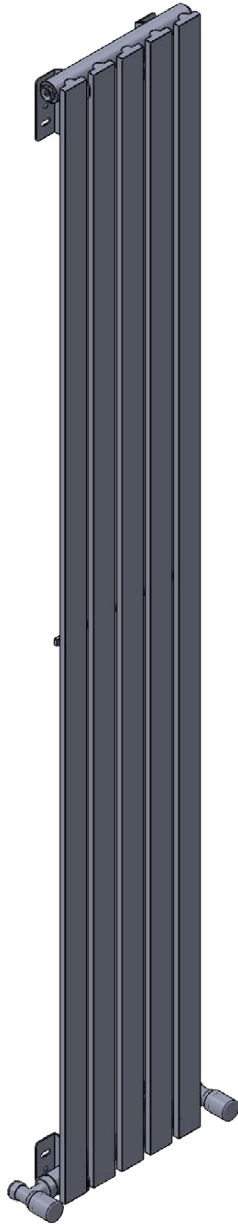

Bryde

All dimensions in millimetres

Manufactured from Mild Steel

SCALE 1:10

E70184

Height: 1800
Width: 252
Depth: 70

Tube Φ : 30sq + 40x10sq
Pipe Centres / Face-Face Cons: 252
Elec. element if specified: n/a
Output @ 50° C Δ T Watts: 351 W
BTUs: 1198 W

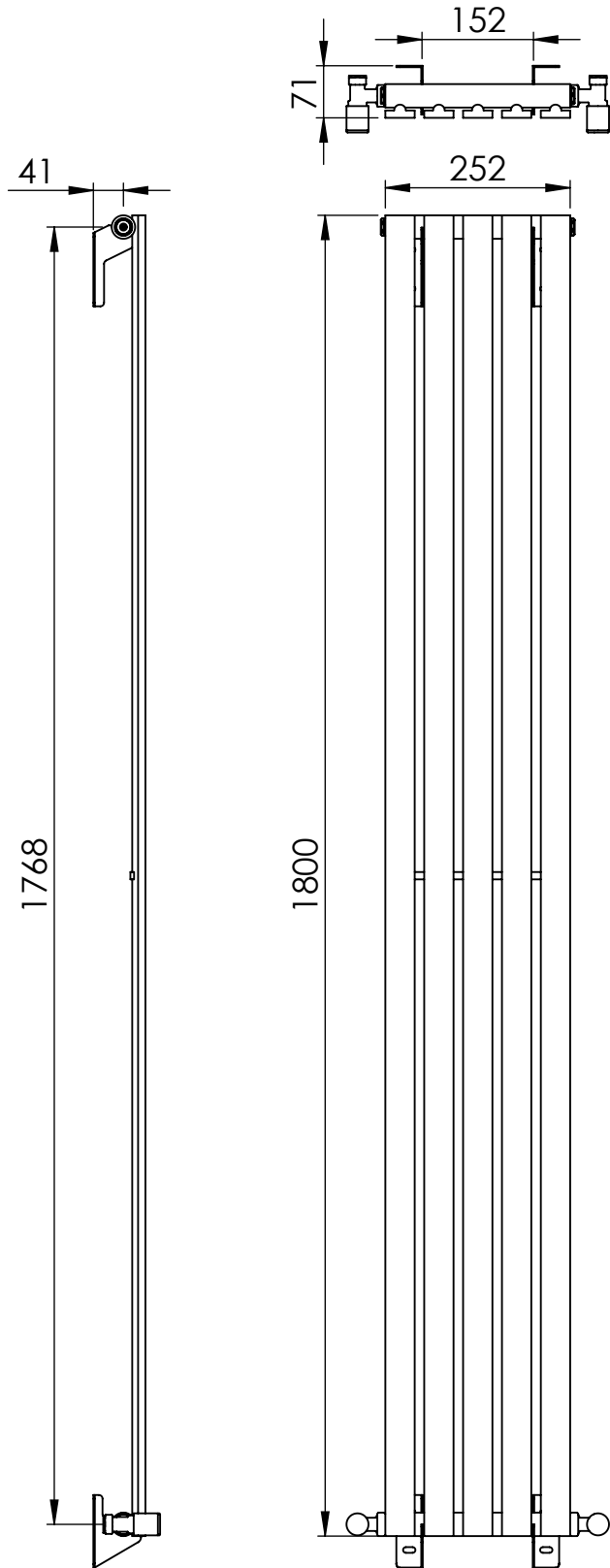
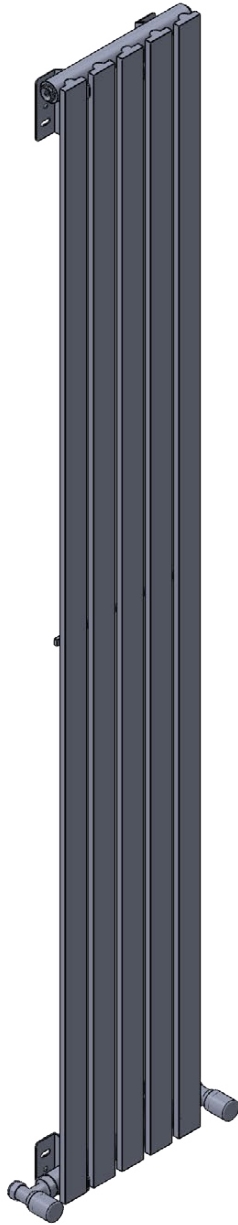

Bryde

All dimensions in millimetres

Manufactured from Mild Steel

SCALE 1:10

E70185

Height: 1800
Width: 358
Depth: 70

Tube Φ : 30sq + 40x10sq
Pipe Centres / Face-Face Cons: 358
Elec. element if specified: n/a
Output @ 50° C Δ T Watts: 491 W
BTUs: 1675 W

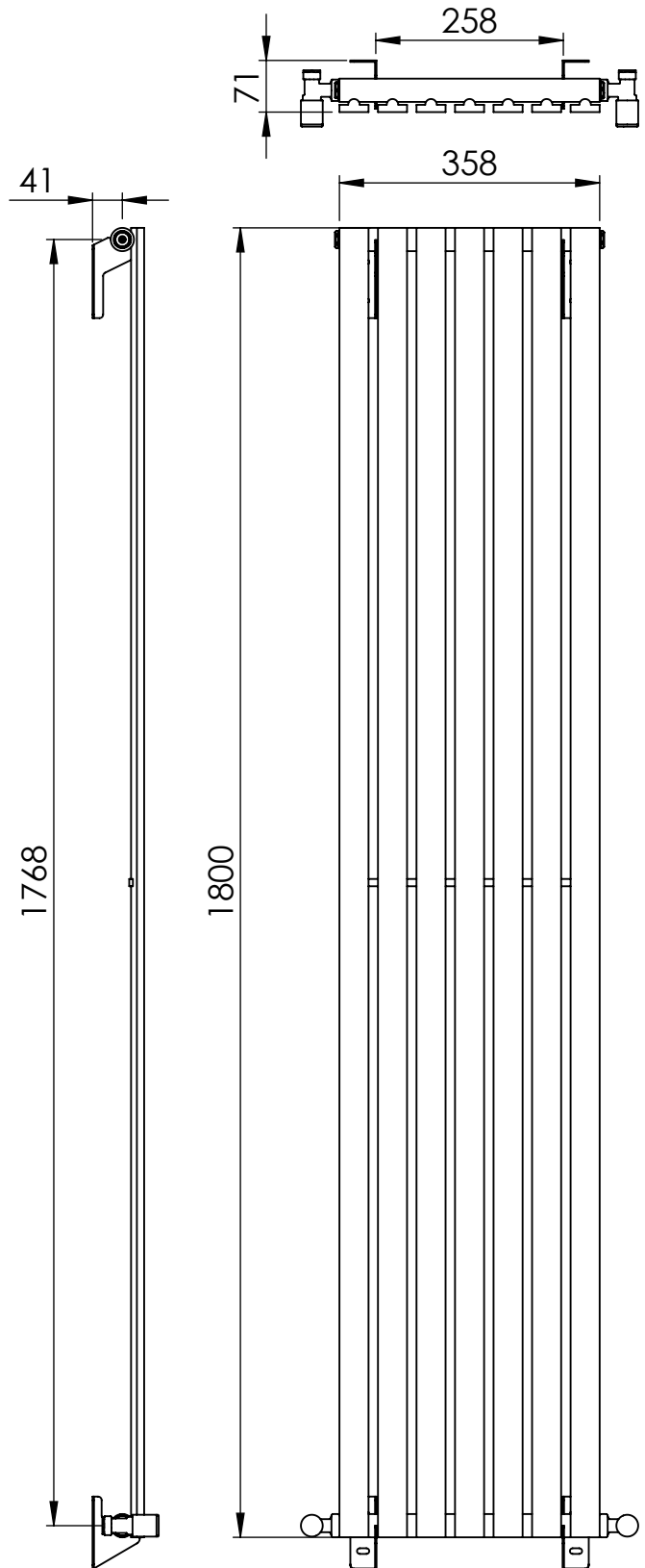
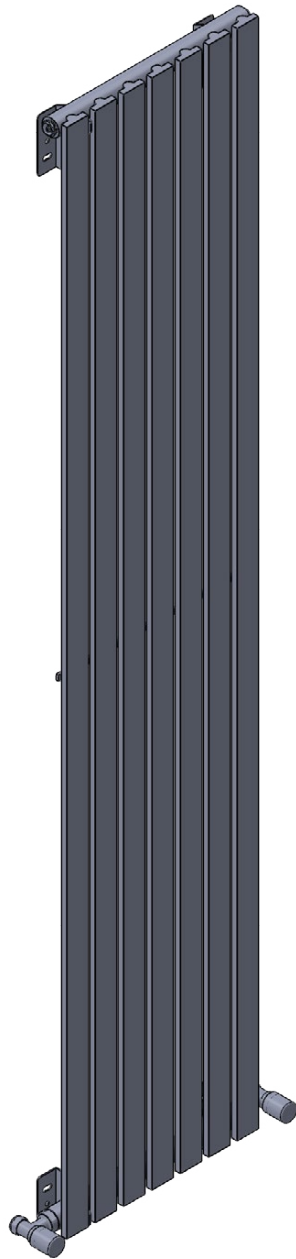

Bryde

All dimensions in millimetres

Manufactured from Mild Steel

SCALE 1:10

E70186

Height: 1800
Width: 358
Depth: 70

Tube ϕ : 30sq + 40x10sq
Pipe Centres / Face-Face Cons: 358
Elec. element if specified: n/a
Output @ 50° C Δ T Watts: 491 W
BTUs: 1675 W

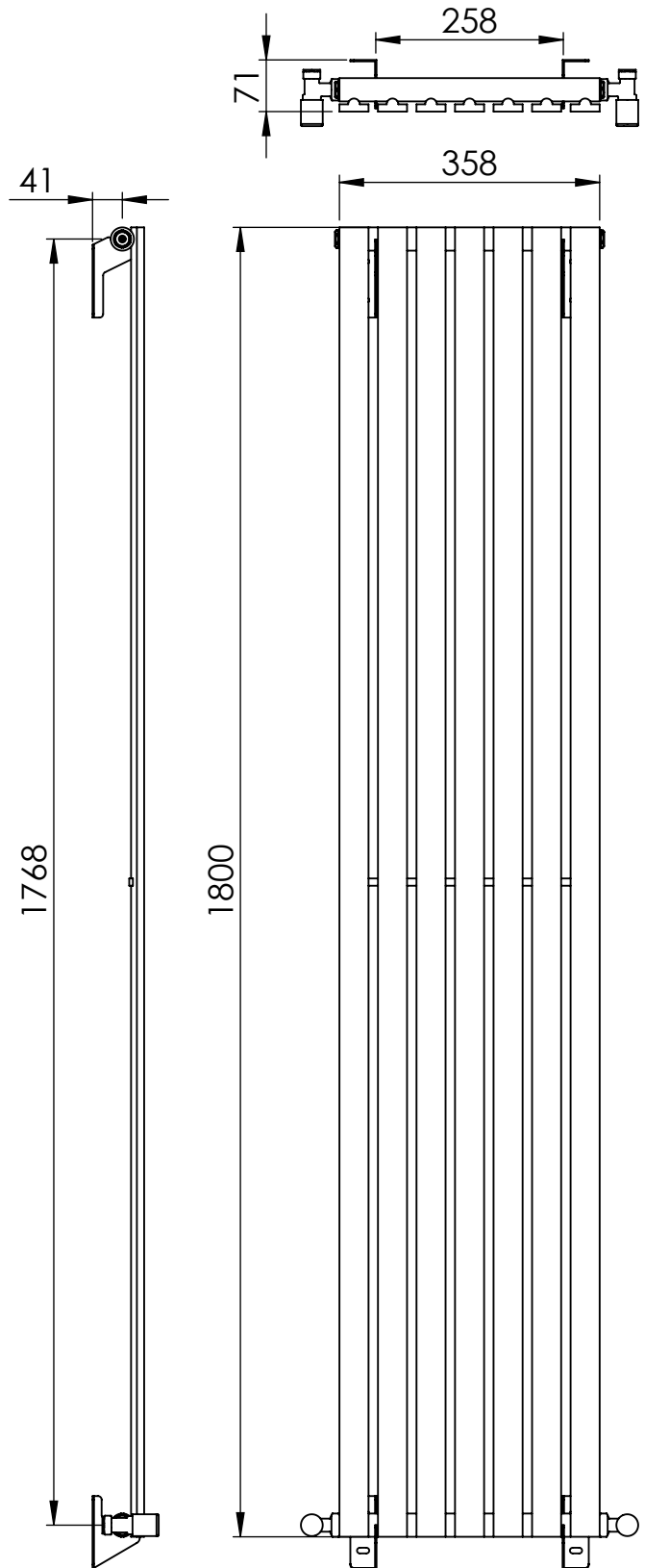
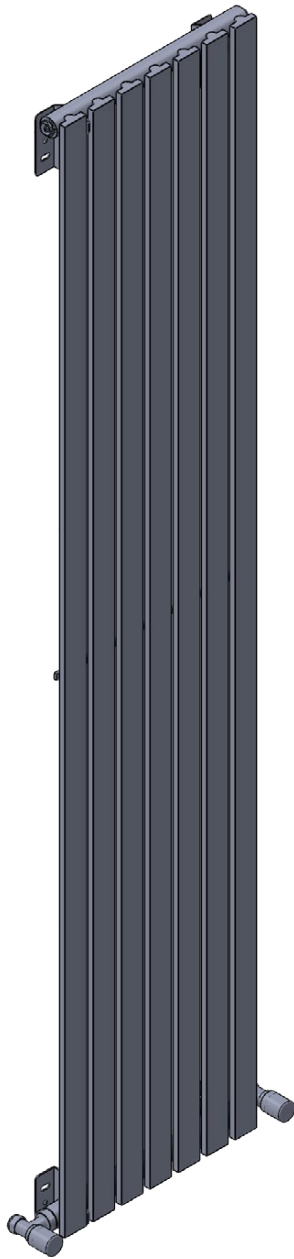

Bryde

All dimensions in millimetres

Manufactured from Mild Steel

SCALE 1:10

E70187

Height: 1800
Width: 358
Depth: 70

Tube ϕ : 30sq + 40x10sq
Pipe Centres / Face-Face Cons: 358
Elec. element if specified: n/a
Output @ 50° C Δ T Watts: 491 W
BTUs: 1675 W

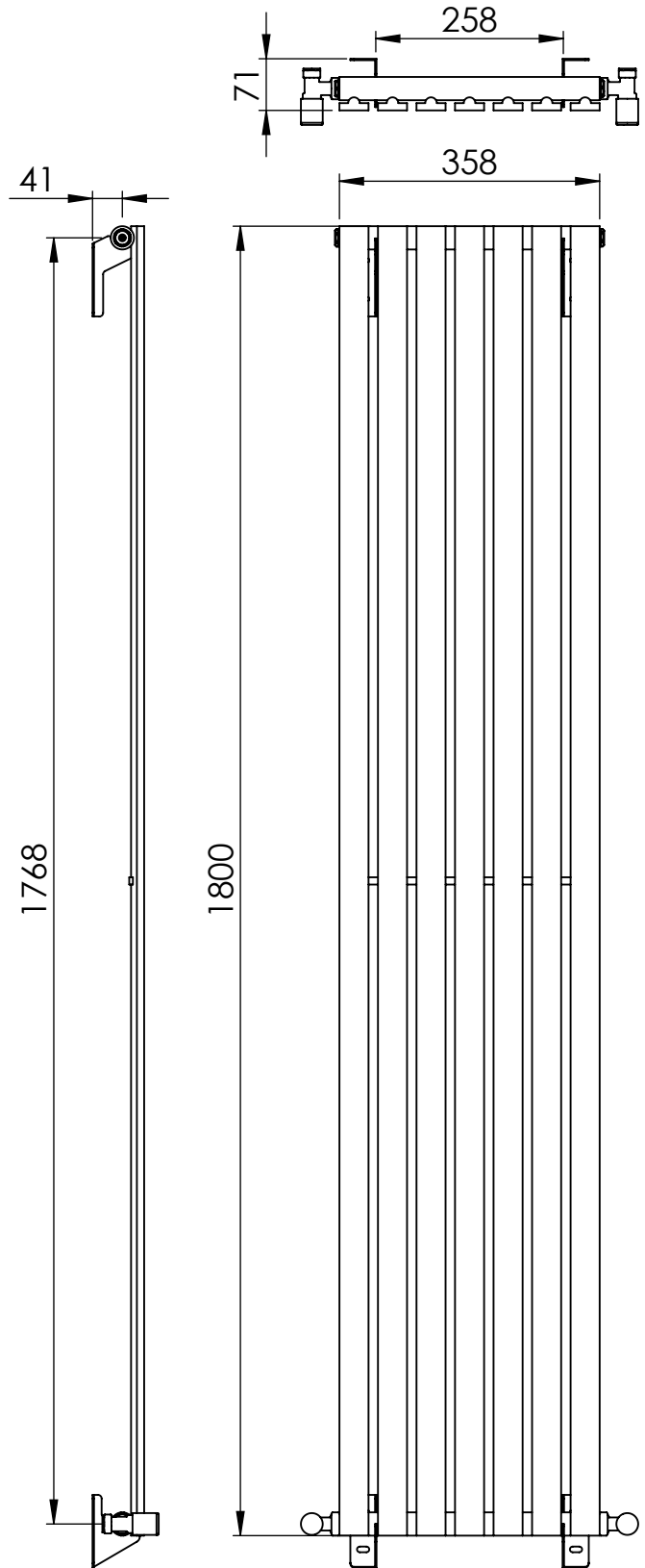
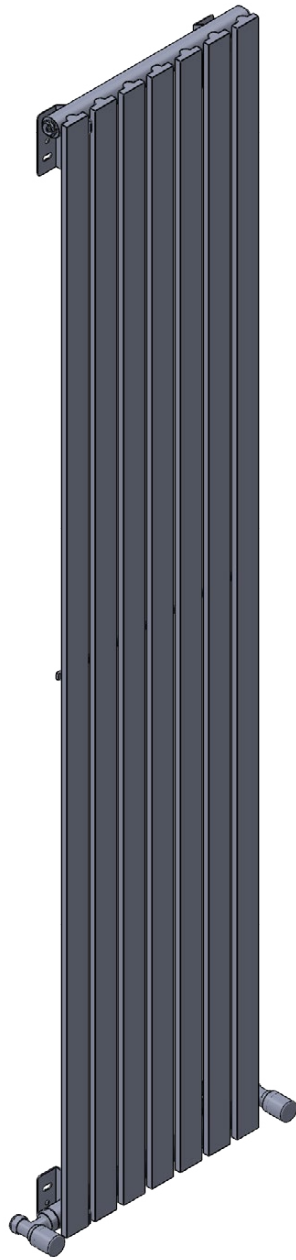

Bryde

All dimensions in millimetres

Manufactured from Mild Steel

SCALE 1:10